

# INTEG M HYBRID INVERTER



## Quick Use Guide

ENGLISH VERSION

# 1 Commissioning

## 1.1 App Preparation

- ① Install the Setup App and Monitoring App with latest version. Please refer to the product nameplate on side of enclosure to get the application.
- ② Register an account on Monitoring APP. If you have got the account and password from the distributor/installer or Solinteg, skip this step.

## 1.2 Inspection Before Commissioning

Check the following items before starting the inverter:

- ① All equipment has been reliably installed.
- ② DC switch(es) and AC circuit breaker are in the "OFF" position.
- ③ The ground cable is properly and reliably connected.
- ④ The AC cable is properly and reliably connected.
- ⑤ The DC cable is properly and reliably connected.
- ⑥ The communication cable is properly and reliably connected.
- ⑦ The vacant terminals are sealed.
- ⑧ No foreign items, such as tools, are left on the top of the machine or in the junction box (if there is).
- ⑨ The AC circuit breaker is selected in accordance with the requirements of this manual and local standards.
- ⑩ All warning signs & labels are intact and legible.

## 1.3 Commissioning Procedure

If all of the items mentioned above meet the requirements, proceed as follows to start up the inverter for the first time.

- ① Turn on the AC breaker.
- ② Turn on the lithium battery breaker. Power on the battery pack manually if a battery is equipped.
- ③ Turn the DC switch, the DC switch may be integrated in the inverter or installed by the customer.
- ④ If the irradiation and grid conditions meet requirements, the inverter will normally operate. The connection time for inverter to grid may take few minutes or even to more according to different country code chosen in the initial settings and the real site grid condition.
- ⑤ Observe the LED indicator to ensure that the inverter operates normally.

## 2 WiFi Module Configuration Guide

1

Prepare a laptop or Smartphone and turn on the WLAN connection.

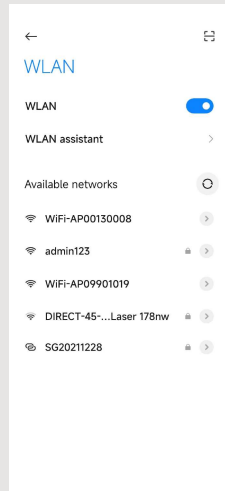

2

Searching for the corresponding WLAN in the WLAN connection list  
“WIFI-AP\*\*\*\*\*”  
(\*represents the last 8 numbers of the inverter SN), and tap connect.

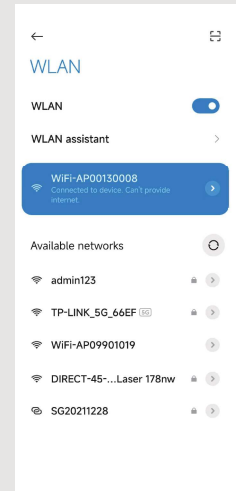

3

Open the browser and enter 10.10.100.254.

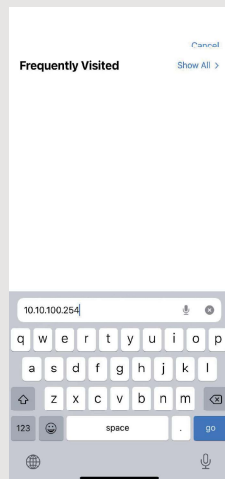

4

Tap “Scan”, A list of WiFi network names pop up.

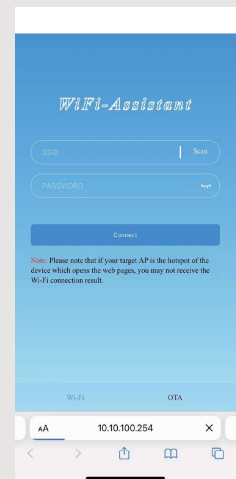

5

Click and select the corresponding router network you want to configure.

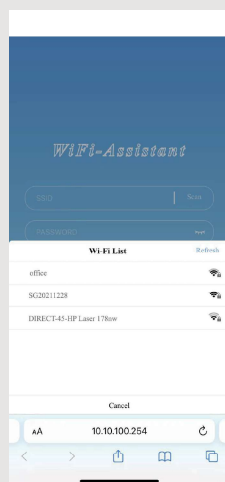

6

Input the password of wireless network, (note the case difference), Tap “Connect”

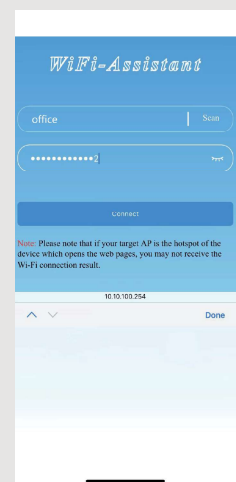

7

If connected successfully “Connection succeeded” will be displayed. After successful configure, the indicator status of WIFI module will be steady on.

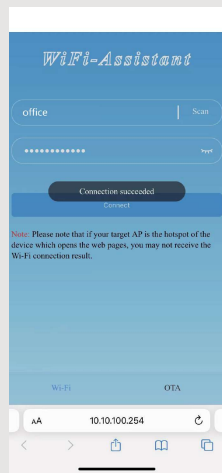

### 3 LAN Module Configuration Guide

If DHCP is enabled on the router, the LAN module does not need to be configured. Otherwise, the LAN module will need to be configured on inverter screen.

- ① Find the “General Settings” by short pressing the button on the inverter screen.
- ② Enter the “General Settings” by long pressing the button on the inverter screen.
- ③ Find “DHCP set” by short pressing the button, then turn off DHCP function by short pressing and long pressing the button on the inverter screen.
- ④ Then set the “IP Address”, “Gateway Address”, “Subnet Mask” and “DNS Address”. Short press to change the number, long press to LAN confirm the number and jump to the next number.

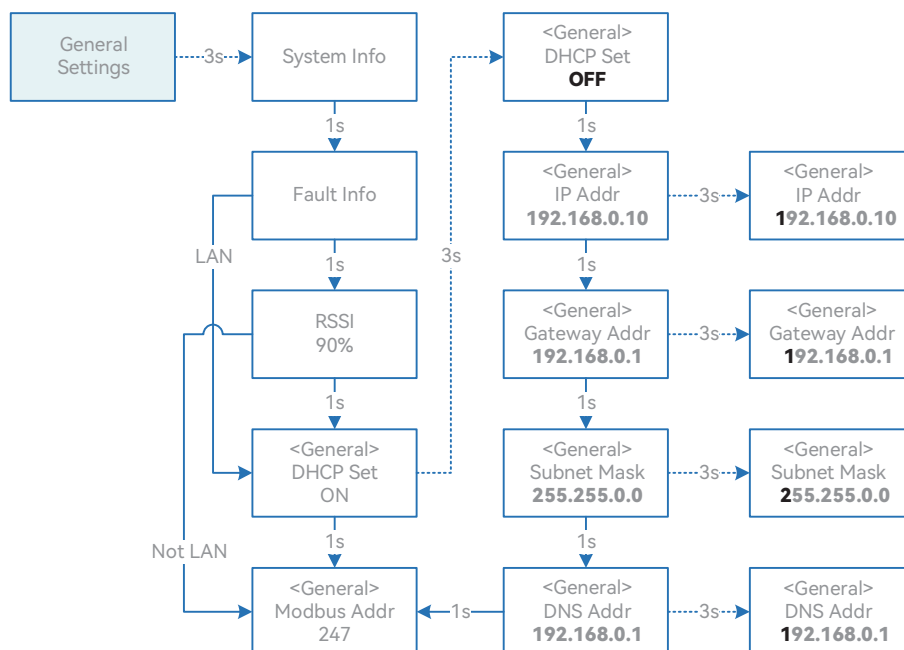

## 4 Local configuration App

Local configuration App is designed for quick configuration of hybrid inverters, offering features such as safety code, battery brand and type, work modes, and off-grid application settings through WiFi direct connection, etc.

There are two connection modes, WiFi direct connection and router connection.

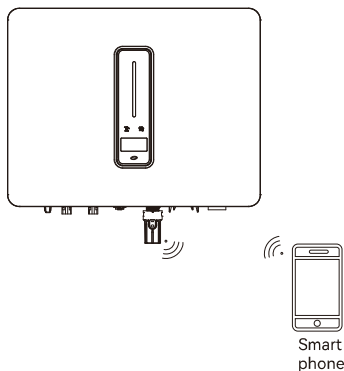

Smartphone connects WiFi monitoring device directly.

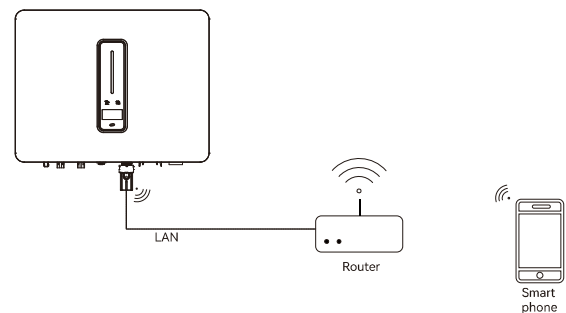

Smartphone and the monitoring device are connected to the router together.

### Connection steps:

①-a. Refer to “WiFi module configuration guide step1~2” to connect the smartphone to the WiFi module. If it is connected, skip this step.

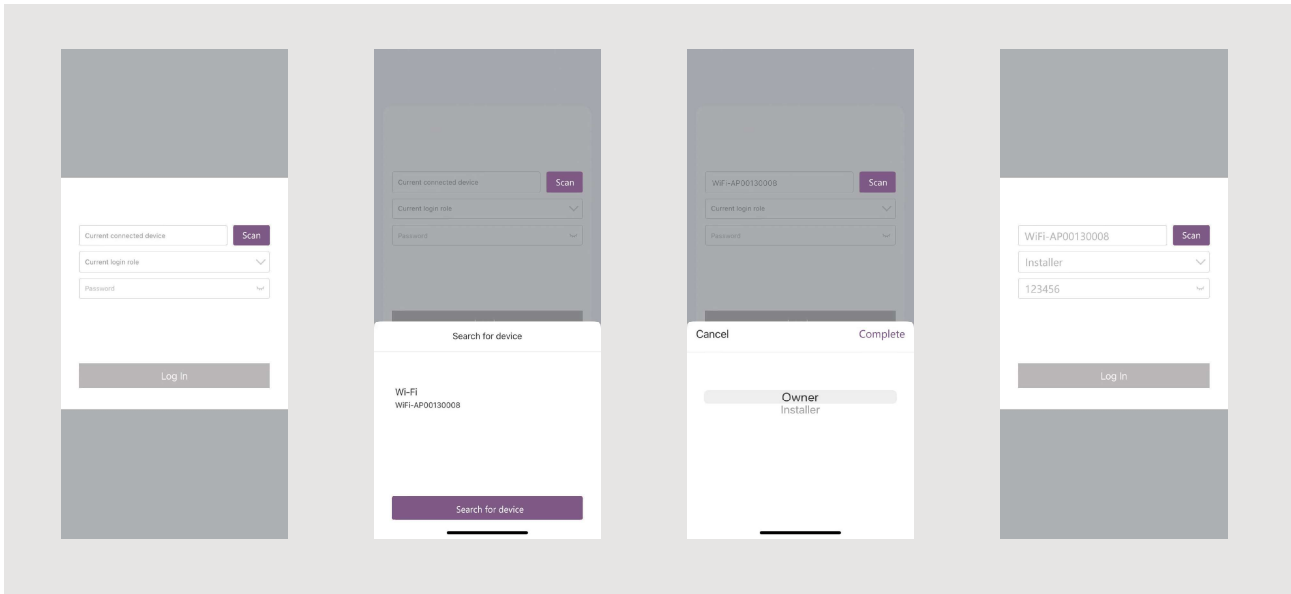

①-b. Refer to “WiFi module configuration guide” or “LAN module configuration guide” to connect the WiFi/LAN module to the router. Then connect smartphone to the same router. If it is connected, skip this step.

- ② Open “Setup APP”, Tap “Scan”, A list of inverter WiFi-AP names pop up.
- ③ Click and select the inverter WiFi-AP which you want to connect.
- ④ Select the login role.
- ⑤ Input the password(123456), Tap “Login In”.
- ⑥ If connected and logged, the Setup APP main interface will be displayed.



## 5 Indicator

### 5.1 Inverter

Indicator	Status		Description
 Power and Alarm Indicator	Off		No power.
	Blue	Quick flashing	Inverter entered self-test status.
		Slow flashing	Inverter entered waiting status.
		Breathe flashing	Inverter works normal.
	Orange	Breathe flashing	Low battery warning, the battery power is about to reach the SOC protection value.
Red	Always on	An alarm or fault is detected, view the fault info on the display.	
 Grid Indicator	Off		Grid lost.
	Slow flashing		Inverter detected grid but not running in on-grid mode.
	Always on		Inverter works in on-grid mode.
 Communication Indicator	Green	Always on	The inverter communication is running normally.
	Green	Flashing	The inverter communicates with EMS or Master inverter through RS485 or CAN.
	Orange	Always on	The inverter isn't communicating with Solinteg smart meter.
	Red	Always on	The inverter isn't communicating with the BMS.

## 5.2 Monitoring Device

Indicator Status	Description
Off	Connection abnormal
Always On	Communicate with the server normally
Slow flashing	The monitoring device is not connected to the router or is not connected to the base station.
Quick flashing	The monitoring device is connected to the router or connected to the base station but not connected to the server.

Button	Description
Press 1 second	Reset device, the indicator goes off for 2 seconds, then flashes normally.
Press 5 second	Restore factory default settings, the indicator goes off for 2 seconds, then flashes once every 2 seconds, until the factory restore is completed.

TEGRATE SOLAR INTELLIGENTLY



[www.solinteg.com](http://www.solinteg.com)