

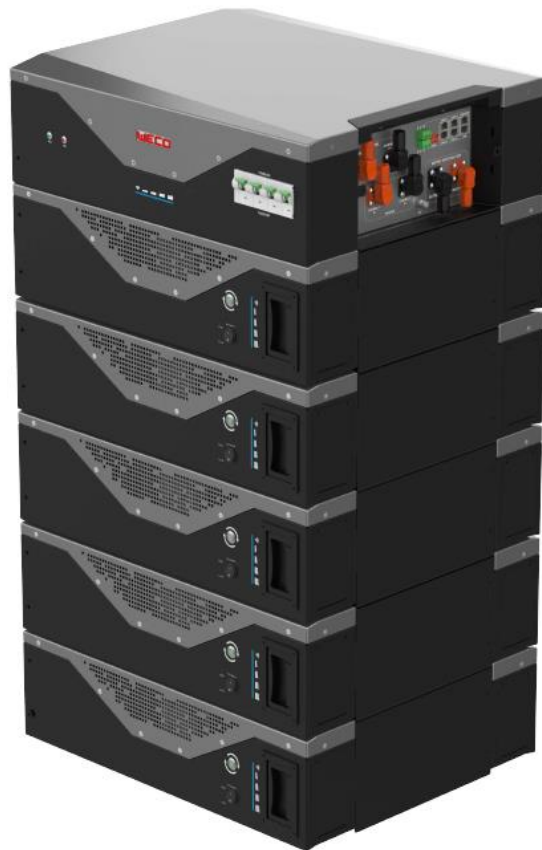

## Installation and User Manual



# WECO 5K3-XP

**EUROPE VERSION NOT FOR USA AND CANADIAN MARKET**

LOW VOLTAGE & HIGH VOLTAGE

## ATTENTION

**THIS MANUAL MUST BE READ ENTIRELY EVEN IF YOU USE THE 5K3XP AS HIGH VOLTAGE YOU MUST READ ALSO THE LOW VOLTAGE SECTION**



**ATTENTION:** The battery could explode and/or be severely damaged if dropped or crushed. Never install the battery if the battery appears damaged.



**ATTENTION:** Appropriate mechanical lifting equipment must be used since the Battery Module weighs 126.3Lbs / 51 kg.



**ATTENTION:** The battery may explode or catch fire if exposed to open flames or other extreme sources of heat.



**ATTENTION:** The battery terminals must be disconnected before commencing any work on the battery.



**ATTENTION:** This battery can accumulate parasite current. Do not touch the B+ and B- terminals. Always check the B+ and B- terminals with a voltmeter.

**Always ensure that there are ZERO volts present on the terminals before performing any operation on the battery; the HV FAST terminals must have their rubber protections in place all the time; remove them only when ready to connect the HV cables.**

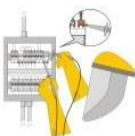

**ATTENTION:** Always wear Individual protection devices, use insulated tools and follow the safety plan of this manual.



**At end of life, these batteries must be disposed of properly by a certified professional company.**



**Do not open the battery cover for any reason.**  
**Opening the battery is a prohibited and potentially dangerous operation.**  
**Do not short the battery terminals as this may cause fire or explosion.**  
**Do not use charging devices, cables, connectors, fuses, switches not approved by WeCo.**  
**The battery and its connections such as cables, switches, fuses, bus bars etc. they must be inspected, cleaned, tightened every three months or whenever necessary also in consideration of the environmental conditions and/or stress of use of the system.**

Contents

**Statement: ..... 6**

**Preface:..... 7**

**Declaration: ..... 7**

**System Design..... 8**

**Battery Operation ..... 8**

    Storage ..... 8

    Temperature ..... 8

    Depth of Discharge (DoD) ..... 8

    Charging ..... 9

    Warranty ..... 10

**Product Overview..... 11**

**Symbols Used ..... 11**

**Battery Module Overview ..... 11**

**Safety Warnings and Notifications ..... 14**

**Warning Statements..... 15**

**General Preparation ..... 16**

**SECTION 1 - STORAGE & PRE-OPERATIONAL PROCEDURES ..... 19**

    1.1 Storage - Transportation – Removing / Relocation of Batteries ..... 19

    1.2 Module Unpacking and Handling ..... 21

        1.2.1 Package Information and System Configuration List ..... 22

    1.3 Wall Mount or Stack Mount Configuration ..... 22

        1.3.1 Battery Dimensions\* (Wall Bracket) ..... 22

        1.3.2 Wall Mount ..... 22

        1.3.3 Stack Mount ..... 26

1.4 Battery Terminal Function Definition .....	28
1.5 Out of the Box Pre-Operational Check.....	29
<b>SECTION 2 - LOW VOLTAGE CONFIGURATION .....</b>	<b>30</b>
2.1 Product Introduction.....	30
2.1.1 Identifying the Individual Module .....	30
2.1.2 Accessory List (Standard Kit 120A Single Module LV) .....	31
2.1.3 Necessary Installation Tools.....	32
2.1.4 Personal Protective Equipment +1000 Vdc Insulated Tools.....	32
2.2 Low Voltage Module Wiring and Set Up .....	33
2.2.1 Battery Connection Terminals .....	33
2.2.2 BATTERY CAN Pin Out .....	33
2.3 Low Voltage DIP Switch Settings.....	34
2.3.1 LOW VOLTAGE PARALLEL CONFIGURATION .....	35
2.3.2 LED Visual Indication Lights .....	35
2.4 Module Activation and Shutdown .....	36
2.5 Low Voltage Parallel Set Up Overview .....	37
2.5.1 Auto ID Assignment and DIP Configuration for LOW Voltage Single Cluster (Parallel Connection) .....	39
2.5.2 Single Cluster DIP and DATA Connection .....	40
2.5.3 Parallel Battery Wiring Connections .....	41
2.5.4 Low Voltage Single Stack Power and Data Connections (15-Modules Maximum) .....	42
2.5.5 LED Bar Indications .....	44
2.6 Stand Alone Battery Front Panel Control.....	45
2.6.1 Start Battery .....	45
2.6.2 Shut Down Battery.....	45
2.6.3 Low Battery – Force Charge.....	45
2.7 Parallel Battery Configuration .....	45
2.7.1 Activation of Parallel Batteries (From Master to last module for a maximum of 15) .....	45
2.7.2 Shutdown of Parallel Batteries.....	46
2.7.3 LV Direct Parallel Connection WITH Certified Inverter BMS Communication (Closed-Loop) .....	47
2.8 Power Connection of a Single Cluster.....	48
2.9 CAN HUB for Multi Cluster Configuration .....	50
2.10 Low Voltage Inverter Compatibility List.....	51
2.11 Low Voltage Inverter CAN PIN OUT .....	52
<b>SECTION 3 - HIGH VOLTAGE CONFIGURATION.....</b>	<b>53</b>
3.1 Product Introduction.....	54
3.1.1 Identifying the Individual Battery Module .....	54
3.1.2 Product Identification and labels.....	55
3.1.3 HV BOX Dimensions .....	56

3.1.4	Battery Module Accessory List (Standard Kit) .....	57
3.1.5	HV BOX KIT (Included in the carton box) .....	58
3.1.6	Necessary Installation Tools.....	59
3.1.7	Personal Protective Equipment + 1000 Vdc Insulated Tool Kit .....	59
3.2	High Voltage Battery Module Wiring and Set Up .....	60
3.2.1	Battery Connections.....	60
3.3	HV BOX Overview .....	62
3.4	High Voltage Module Configuration .....	64
3.5	High Voltage DIP Switch Settings.....	65
3.5.1	Serial Tower Connection #1 Set-Up of the HV Box CAN Communication Loop.....	66
3.6	Serial Battery Wiring Connections .....	67
3.6.1	High Voltage Power Connections .....	69
3.6.2	DATA Connections (Example of 12-Modules) .....	70
3.6.3	HV Box and Battery Module Power Connection.....	72
3.6.4	Single HV Box Connection to an Inverter .....	73
3.6.5	Multi HV Box Connection .....	735
3.6.6	Multi HV Box Connection .....	757
3.7	HV Box ADDRESS .....	78
3.7.1	LED Visual Indication Lights .....	81
3.7.2	Stand-Alone Battery Front Panel Control * FORCED CHARGE* .....	82
3.8	HIGH VOLTAGE INVERTER COMPATIBILITY .....	84
3.9	DRY CONTACTS SETTINGS .....	84
3.10	WECO BMS - LOW VOLTAGE PC SOFTWARE for 5K3-XP .....	87
3.11	WECO BMS - VOLTAGE PC SOFTWARE for 5K3-XP.....	92

## Statement:

The information and guidance contained in this manual is related to the **WECO 5K3-XP** Stackable model of battery. This manual contains various sections:

**Section 2 is for LOW VOLTAGE APPLICATION**

**Section 3 is for HIGH VOLTAGE APPLICATION**

In case of product upgrades or other reasons, this document will be adjusted accordingly. Unless otherwise agreed, this document is intended to be used only as a guide, and all statements, information and advice in the documentation shall not constitute any express or implied action in contradiction to local regulations or standards.

For more information, please contact us.

The official information and the latest data sheet are available on [www.wecobatteries.com](http://www.wecobatteries.com).

It is essential that the Battery Module is equipped with the latest firmware version available. New batteries are equipped with the latest Firmware Version, however before commissioning please check via Bluetooth or WiFi APP the latest FW release, or search it on <https://wecobatteries.com/download-area/>.

From time to time, firmware will be updated to improve the functionalities and battery capabilities.

The latest version of the firmware is always available free of charge and can be updated by your local installer. You can always contact [service@wecobatteries.com](mailto:service@wecobatteries.com) for additional information on the upgrade procedure.



### ATTENTION

The release of "critical updates" implies the installation of the mandatory FW within 60 days in order not to lose the right to the warranty, see Limited Warranty conditions.

5k3 XP batteries are equipped with integrated Bluetooth and WiFi device, the update can be done directly from phone with Bluetooth APP without the necessity of creating an account or the needs of a local wi-fi network.

#### NOTICE:



This Battery Module is designed to be used indoor.

The STANDARD IP20 degree of protection does not allow installation in outdoor environments even if sheltered from the weather.

The Battery Modules must be stored indoors in a clean, dry, cool location in a limited access area.

**DO NOT OPEN THE BATTERY COVERS DO NOT REPAIR DISMOUNT OR DISASSEMBLE ANY PART OF THE BATTERY  
DO NOT OPEN THE BATTERY COVER AS THIS OPERATION IS FORBIDDEN AND VOIDS THE WARRANTY**

## Preface:

Thank you for choosing our product.

We will provide you with a high-quality product as well as reliable after-sale service. To protect against harm to both personnel and product, please read this manual carefully.

This manual provides detailed information on operation, maintenance and troubleshooting of the product, as well as health and safety advice.

## Declaration:

The manufacturer holds the right of final explanation of any content in this manual.

The first release of this manual was issued in February 2022 for the European Market.

The Battery Capacity is intended to be 5,3kWh in the range 100-0% of the BMS.

The capacity is not constant at every cycle and may vary based on many factors, the energy degradation is not constant over the time or cycles and is heavily affected by the temperature, C-Rate and DoD (Depth of Discharge).

First 500 cycles are typically affected by higher decrease in capacity compared to the following cycles.

Before buying this product read the warranty terms available on our website.

Always check the latest technical data on our web site as might be changed.

If this manual is not clear to you, do not buy or install the battery, ask for technical meeting writing to

[service@wecobatteries.com](mailto:service@wecobatteries.com).

The performance Limited Warranty Documents sets the parameters to obtain the best performances from the battery based on the Standard test Condition used by WeCo.

Any additional details about this battery, its BMS and the compatibility with the inverters can be requested by writing to

[weco@wecobatteries.com](mailto:weco@wecobatteries.com).

This battery and its accessories are intended to be installed, maintained and supervised only by expert and qualified installers.

All trademarks shown in this manual belong to their legitimate owners; trademarks of third parties, product names, trade names, corporate names and companies mentioned may be trademarks owned by their respective owners or registered trademarks of other companies and are used purely for explanatory purposes and for the benefit of the owner, without any purpose of violation of the copyright in force.

The evaluation of the product is an important and necessary phase and must precede the purchase, it is recommended to evaluate the latest datasheets made available on [www.wecobatteries.com](http://www.wecobatteries.com) website or request a copy directly from

[weco@wecobatteries.com](mailto:weco@wecobatteries.com).

Our products and manuals are mainly dedicated to installers and technical experts in the sector with specific qualification for electrical installations.

The manual, the system certification and the test certificate "first ignition" of the entire system performed according to the National Standards of your country, must be delivered to the end user after adequate training on the use and maintenance of the battery and the system in general.

These batteries are intended to be marketed to be integrated into more complex systems installed only by professional operators.

After reading the manual in full, we hope that you can buy our products.

Before buying, please carefully evaluate the technical characteristics with the data provided on our website or by requesting the updated version of the battery model currently in production.

Datasheets may be subject to change for market or industrial needs, therefore datasheets present on third-party websites or otherwise distributed in the past may not be updated and in any case correct. Get the latest official versions from

[weco@wecobatteries.com](mailto:weco@wecobatteries.com).

The pre-purchase evaluation is an important phase and for this reason it must be conducted carefully and perhaps with the help of qualified and experienced technicians if your knowledge on the subject is not sufficient.

WeCo batteries are developed for domestic and industrial applications and can only be installed and maintained by experienced and qualified personnel, they are not produced for direct sale to individuals.

ESS (Energy Storage Systems) batteries for domestic applications are designed to maximize self-consumption of energy from renewable sources. The use for backup systems, or for UPS systems, is possible within the charge/discharge current limitations of the ESS.

This manual provides detailed information on the operation, maintenance and troubleshooting of the product, as well as health and safety advice; the information contained in this manual may not be sufficient to cover specific applications, so if your specific case is not mentioned, please do not purchase our batteries until every technical and safety aspect of your specific application has been clarified. You can request technical support from [service@wecobatteries.com](mailto:service@wecobatteries.com).

WeCo offer two types of warranty on its products, the Manufacturing defects also called functional warranty and the performance warranty. More information can be found in this manual and on the specific warranty document available for each battery model.

## **SYSTEM DESIGN BY EXPERT TECHNICIANS**

Systems Design is the process of defining the architecture, components, modules, interfaces, and load data for a system to meet specified requirements.

For a solar system these components are the photovoltaic modules, the inverter / charge controller and the batteries as well as the different interfaces of these components.

These systems must be integrated with each other in accordance with their respective technical rules and must be compatible with each other.

The design must take into account the functional guarantees and performance guarantees in order to guarantee the end customer full satisfaction of the product he will use.

For safety reasons, if the battery does not operate at the temperatures, currents and DOD specified in the performance guarantee requirements, it must be inspected with appropriate frequency according to the conditions of use applied.

WeCo bases guarantees and safety according to the standard conditions of use described above, heavier uses and at suboptimal temperatures will have direct effects on the premature aging of the battery and with it the intrinsic safety.

## **Battery Operation**

There are several factors that affect the operation of the battery that could impact its ability to deliver capacity and life expectancy.

### **STORAGE**

Battery Module shall be stored in original packaging, in a clean, level, dry, cool location indoors.

Recommended storage temperature is 77°F / 25°C, but different storage range are acceptable:

range of 14°F to +32°F / -10°C to +0°C: inspection\* and recharge\*\* every three months required.

range of 32°F to +86°F / +0°C to +30°C: inspection\* and recharge\*\* every six months required.

range of 86°F to +113°F / +30°C to +45°C: inspection\* and recharge\*\* every three months required.

(NOTE: max charging current is 0.1C at a temperature not lower than 15°C).

Max SoC for sea shipping is now 30% as per the recent changes of the UN 38.3 regulation.

\*Inspection parameters – identify the State of Charge (SOC), look for alarms and address them accordingly, look for physical damage to the Battery Module.

\*\*Charge at 0.1C up to 50% SOC and then discharge to the limit of SOC allowed by the local regulations. Suggested SOC 30%~50% when stored on land.

If shipped by sea, you must refer to the UN38.3 standard; if by road, refer to the local codes.

### **Operating Temperature and Thresholds**

Many chemical reactions are affected by temperature and this is also true for the reaction that occurs in a WeCo storage battery. The chemical reaction of a lithium ion is slowed down by the lowering of the temperature of the electrolyte contained in the battery, which results in a lower capacity and a higher rate of long-term performance decay in direct proportion to the departure from the optimal temperature prescribed by WeCo.

A new battery providing 100% of the nominal capacity at 25°C (77°F) will provide only about 75% of the nominal capacity at 10°C.

At temperatures below -7°C (+19.4°F) the BMS will only allow 0.05C of charge current only for emergency circumstances; at

temperatures below -10°C(14°F) charging is prohibited.

These thresholds do not mean that the battery warranty also applies under such conditions, although permitted by the BMS.

The logic of the BMS does not coincide with the prescribes and thresholds must be from those customers who intend to benefitting from the performance guarantees.

The respect or not of the performance warranty thresholds to benefit the performance guarantees is up to the end customer, while the limitations inherent in the battery safety thresholds are set by the BMS as extreme values.

The warranty conditions (Functional and Performance) are well described in the document "Limited Warranty" and must be read before purchasing the product.

For example, the functional guarantee (pursuant to European legislation) prescribes that the installation of batteries with IP 20 and 30 must be indoors, ie indoors, with humidity and controlled temperature, while the performance guarantee prescribes the charge and discharge must be carried out between 20 ° C (68°F) and 25 ° C (77°F) at 0.5C; any use outside of these requirements is not covered by the performance guarantee.

Most battery capacity/life issues can be traced to improper charging. Improper charging settings may lead to an overcharging or undercharging condition, any wrong charging process will affect the life of the battery or its ability to retain energy.

The lower the C-Rate of the charging/discharging process the more the battery will benefit from long term performance.

### **Depth of Discharge (DoD)**

Depth of discharge is a function of design. The deeper the discharge per cycle, the shorter the life of the battery. A cycle is a discharge and its subsequent recharge regardless of depth of discharge, it considers the energy IN and OUT.

The lower the DOD value, the higher the battery longevity and the capacity retention over the time.

The depth of discharge is a function that is implemented through the setting of the hybrid inverter, compatible with WeCo.

The deeper the discharge, (e.g. DoD 100% means completely draining the battery), the shorter the battery life over its estimated lifetime.

A cycle is a discharge and its subsequent recharge regardless of the depth of discharge.

The number of cycles and the specific DoD will affect the expected life in years that the battery/battery system will provide before replacement.

To maximize the remaining capacity over the useful life of the battery, it is recommended to set the DoD of the inverter to the value of that will not exceed 90% , this will help the maintenance of health (SoH) for longer period of time.

The capacity of the battery is not constant at every cycle and may vary based on many factors, the energy degradation is not constant over the time or cycles and is heavily affected by the temperature, C-Rate and DoD (depth of Discharge).

Typically, the decrease in capacity every 500 cycles conducted as per the STC is set to be in the range -2~3% however the First 500 cycles are typically affected by higher decrease in capacity compared to the following cycles. After 7000 cycles the residual capacity shall be 70% (if the battery is correctly used within the recommended values and maintained over years.

Before buying this product read the warranty terms available on our website.

The functional guarantee indicates the maximum DoD up to 100% because both the logic and the battery hardware have been verified and tested to be achieved (each inverter protocol might have different requirements and the 100% DoD could not be achieved as per the agreement between the inverter manufacturer and WeCo.

Performance guarantee sets the maximum value of DoD % (to be set in the inverter) must not exceed the value of 90% at 25°C 0.5C without prejudice to the previous requirements.

### **C-Rate**

Value of the Current used to charge and discharge the battery is expressed in C (1C = 100A, 0,1C= 10A in case of the 5K3 100Ah battery).

### **Charge/Discharge**

Most capacity/battery life issues can be traced back to improper charging also due to improper installation. Improper charging settings can lead to an overload condition or excessive discharge or current out of range for temperature condition and SOC%.

WeCo guarantees only batteries connected via BMS CAN line to the compatible inverter (see compatibility list on [www.wecobatteries.com](http://www.wecobatteries.com)) and used according to the warranty requirements published on the site.

CAN/BMS communication is essential both for reasons of active and passive safety and to be able to conduct all active control interactions with the inverter.

The BMS has dynamic algorithms that vary according to current or previous conditions stored during the discharge or stand by charging phases.

Modern inverters / charge controllers are equipped with CAN / BMS interface and no special settings are required to charge and discharge the battery, except for the setting of the charge / discharge power and the DoD% (if the customer wants to comply with the STC requirements he must read and comply with the warranty conditions defined STC and set them on the inverter).

The maintenance at optimal temperature instead must be guaranteed by the technical room and air conditioning equipment installed in it, the inverter is not able to interact with the settings in reference to the temperature of the environment in which it is installed, also because inverter and battery could be in different environments exposed to different environmental factors.

### **Guarantee (Functional Guarantee against manufacturing defects) and Performance Guarantee**

Although the BMS of the battery allows a wide range of use in terms of both temperature and charging currents, this should not be interpreted as an implicit authorization to use the battery at these levels with reference to the performance guarantee.

For the purposes of the performance guarantee, it is mandatory that the battery is used within the range of temperature and current, charge/discharge current and depth of discharge indicated in the warranty and also reported in these paragraphs.

Any other use, even if permitted by BMS thresholds, is not covered by a performance guarantee.

### **Firmware Updates**

In case of firmware updates to the BMS as a result of improvements, corrections or for other reasons, this manual and warranties may be updated accordingly. Check the critical firmware release notes on [www.wecobatteries.com](http://www.wecobatteries.com) with your distributors; critical release firmware must be installed as per warranty requirements: To get support if your system is not equipped with a WiFi module please contact [service@wecobatteries.com](mailto:service@wecobatteries.com).

All WeCo batteries produced from the beginning of 2019 can be equipped with a WiFi system for connection on WeCo Cloud, this solution ensures that they are always updated to the latest FW version notified in the APP, the Upgrade function must still be driven by the user as during the update the battery must be turned off for safety reasons and it is therefore necessary to plan this action in such a way that no inconvenience is created for users of the system.

Buit-In and External Dongle having the same functionalities described above.

The FW update can also be performed locally via Bluetooth App, even in the absence of WiFi; you must have a 4G connection and keep the Bluetooth App open until the App appears: "NEW FIRMWARE AVAILABLE" after which you can reach the battery in an area not covered by data signal and/or Wi-Fi and perform the FW update.

## Imprint

Unless otherwise agreed, this document is intended to be used only as a guide to installation, maintenance and management of the product, all statements, information and advice contained in the documentation do not constitute any explicit action or implied statement in contradiction with local regulations or standards.

For more information, please contact us.

The official information and the most recent technical data sheet are available on [www.wecobatteries.com](http://www.wecobatteries.com); and in any case can be requested in real time at [weco@wecobatteries.com](mailto:weco@wecobatteries.com); hyperlinks, third-party links, digital datasheets published on social media web or printed paper support may not be updated to the current version of the product.

Before purchasing the product, check the site for updated technical data and warranties to date.

It is essential that the battery unit is equipped with the latest firmware version available on [www.wecobatteries.com](http://www.wecobatteries.com) or on the WeCo APP.

From time to time, WeCo will release a new firmware to improve the functionality of the battery, if your battery will be equipped with WiFi (Paid accessory) and you will be registered on our APP, the new firmware will be visible in the APP and updatable with a simple click from your phone.

The latest firmware version is always available for free; the battery firmware can be updated by the local installer via RS232/USB and Windows PC (reserved for technical installers) or via APP for batteries equipped with WiFi dongle.

You can also write an email to [service@wecobatteries.com](mailto:service@wecobatteries.com) to understand and get support in the upgrade process.



### ATTENTION

The 5K3-XP battery module is designed to be used only indoors in temperature-controlled environments.

The IP degree of protection does not allow installation in outdoor environments even if protected from the weather.

The definition INDOOR means the indoor environment, the room must be closed to unauthorized persons, ventilated and dry.

Use in an external environment or not compliant with the IP grade is prohibited and potentially dangerous for the health of people and / or things.

## Manufacturing Warranty

Although the BMS of the battery allows a wide range of use, both in terms of temperature and charging currents, and DOD this should not be construed as an implicit authorization to use the battery at these levels.

For the purposes of the Performance Warranty, it is mandatory that the battery is used within the range of temperature and charge/discharge current, and Depth of Discharge indicated in the Performance Warranty.

See Limited Warranty Document.

## Performances Warranties

It is an additional Warranty and only apply to batteries connected via BMS line to an approved inverter, the working parameter of the battery must remain within the performance warranty terms.

Any other use, even if permitted by the BMS ranges, is not covered by the Performance Warranty.

See Limited Warranty Document available on the web site [www.wecobatteries.com](http://www.wecobatteries.com).

## Product Overview

The WeCo 5K3-XP is a Stackable Battery Module with a DUAL VOLTAGE module that can be used in a Low Voltage configuration or in a High Voltage configuration.

For LOW VOLTAGE (48.5-58.4 Vdc)\* Configuration Refer to Section 2

For HIGH VOLTAGE (80/200-750 Vdc)\* Configuration Refer to Section 3

\*Voltage ranges are estimates only as they always depend on interactions with other devices and ambient conditions.

## Information in this Manual

### About this Manual

This manual relates only to the 5K3-XP (EUROPE VERSION) Stackable Battery Module. Only trained and authorized personnel should install, troubleshoot, or assist WECO in local repairs of these Battery Modules. This manual should be reviewed in its entirety for proper storage, installation, and operation of the Battery Module.

### Use Range and Voltage Range

This installation guidance applies for the High Voltage and Low Voltage Inverters.

Make sure to use the correct inverter charging parameters before connecting to the battery.

Each WeCo 5K3-XP Battery Module has two different circuits and depending on the inverter voltage range, the installer must choose the correct battery configuration for that range, never use the LOW VOLTAGE screw terminal for serial connection, never use the HIGH VOLTAGE terminal for LOW VOLTAGE connection or to recharge the battery as the HV CIRCUIT on the Battery Circuit is not protected by contactor or MOSFET for Overvoltage (This protection function is made by the HV BOX).

HV BOX for EU (EMEA VERSION) is designed to operate from 80 up to 750Vdc, if you need a HIGH Voltage HV BOX XP please order the HV BOX XP type B (EU type B version with Voltage Ranges starting from 150Vdc to 1000Vdc).

## Additional Information

Product specifications subject to change without notice.



### IMPORTANT NOTICES:

HV BOX (EMEA VERSION) has a minimum startup voltage of 80 Vdc, (two 5K3XP modules in serial connection) however it is suggested to use a minimum of four modules to have an adequate buffer of energy to prevent low voltage shutdown of the HV BOX during a long period of the inverter on standby, or due to solar charger inactivity.

The Start Up of the Inverters is typically above 100Vdc, make sure to consider the Inverter Battery Voltage Range Before setting up the battery Cluster.

The HV BOX can turn on with a minimum of 80Vdc however it is mandatory to comply with the inverter Nominal Voltage. Below 80Vdc the HV BOX will shut down and the safety protection cannot be granted.

In an HV system the cluster total usable energy might be reduced due the imbalances between modules, always consider to fully balance the single modules before composing the HV cluster to maximize the energy usage of the cluster.

NOTE:

A difference of 0,5V between modules connected in series can result in over 40% of less usable capacity due the BMS intervention for Higher or Lower voltage limit of the single module into the HV CLUSTER.

## Symbols meaning



### CAUTION:

CAUTION represents hazardous situations which can cause injuries if not avoided.



### NOTICE:

NOTICE represents the situations which can cause damage to property if not avoided.



### INFORMATION:

INFORMATION provides tips that are valuable for optimum installation and operation of the product.

**HV BOX XP is not compatible with LV/HV batteries.**

**XP batteries are compatible with LV/HV batteries with limitations.**

**In case of expansion of a Custer composed of batteries of the LV/HV model with XP batteries, it is necessary to replace HV BOX LVHV with XP model. See appropriate manual.**

## Battery Module Overview

INFORMATION provides tips that are valuable for optimum installation and operation of the product.

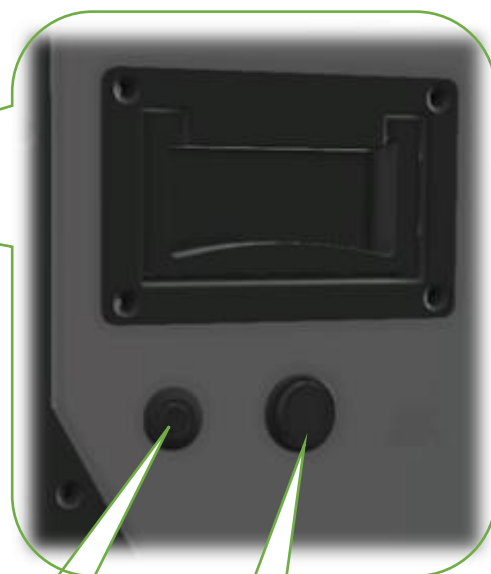

RUN BUTTON

POWER SWITCH

CONNECTION HUB PROTECTION PLATE



UPPER REMOVABLE BRACKET

WALL BRACKET

LOWER REMOVABLE BRACKET

REMOVABLE HANDLES

STRUCTURAL FEET



**ATTENTION:**

THE BATTERY IS DUAL VOLTAGE –  
IT CAN BE INSTALLED IN EITHER A HIGH VOLTAGE CONFIGURATION OR A LOW VOLTAGE CONFIGURATION,  
BUT NEVER AT THE SAME TIME.

BE AWARE OF THE DIFFERENT CONNECTION METHODS AND THE SPECIFIC USE OF THE TERMINAL CONNECTORS.

**LOW VOLTAGE ONLY**  
SCREW TERMINAL

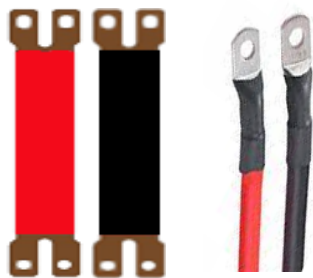
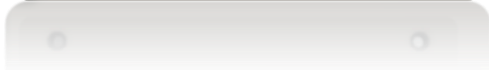

**LOW VOLTAGE**  
PARALLEL CONNECTION



**HIGH VOLTAGE ONLY**  
FAST CONNECTORS

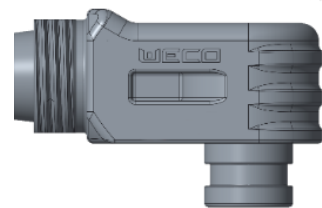
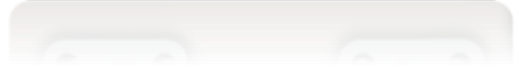
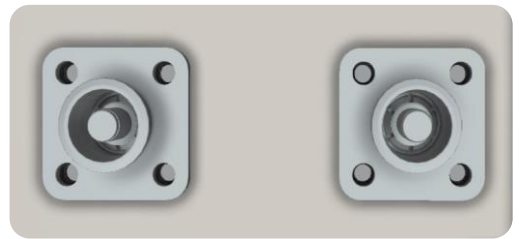

**HIGH VOLTAGE**  
SERIAL CONNECTION

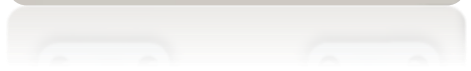

## Safety Warnings and Notifications

Installation environment requirements: The WeCo 5k3-XP dual voltage Battery Module is designed for household/commercial purposes. For installation, it must be installed in a location complying with IP20. Installations in locations that do not comply with IP20 may cause failure and/or damage to the product, in which case the product warranty will become void.

Never change or replace HV or LV connectors or cables with parts not approved by WeCo.

Do not change the cables with cables having different length or cross section, under any circumstances.

### Safety Guidelines



#### CAUTION:

Adequately insulated tools as defined by IEC 60900:2012 “Standard Specification for Insulated and Insulating Hand Tools” shall be used at all times to ensure battery terminals are not short circuited.

All electrical connections on the WeCo 5K3-XP Battery Module shall be made only by qualified personnel.

When installed and operated in accordance with this manual, the WeCo 5K3-XP Battery Module will perform in a safe and reliable manner in accordance with the battery operating specifications.

Subjecting the battery to an unsuitable operating environment or to damage, misuse or abuse may result in health and safety risks such as overheating or electrolyte smoke potential. All personnel must comply with the safety precautions and observe all warnings as detailed in this document. If any of the safety precautions or procedures detailed in this manual are not fully understood by the reader, the reader must not perform any operation on the battery until they have contacted the WeCo technical service representative for clarification and confirmation of understanding of the correct procedure.

The safety guidelines included in this document may not include or consider all the regulations in your area of installation/operation. When installing and operating this product, the installer must review and consider applicable Federal, State and Local laws and regulations in accordance with the industry standards of the product.

Installation personnel shall not wear metallic objects, such as watches, jewelry and other metal items when performing installations. Do not store un-insulated tools in pockets or tool belt while working in vicinity of battery to avoid short circuits and personal injuries.



#### CAUTION:

The weight of an individual WeCo 5K3-XP Battery Module is 119 lb /54 kg. Please use original packaging and follow all safety precautions if the Battery Module is to be moved, to avoid damage to the product and personal injury.

Relocating a battery to another system is not suggested as the aging and the differences in usage might affect the safety of the system when connected together. Always use new batteries for expansions of existing systems. Expansions of existing systems are allowed within 300 cycles or 1 year.



#### ATTENTION:

The typical high voltage configuration should have a minimum number of 4 modules in order to reach at least 200 Vdc in series. However, the HV BOX XP type A can operate starting from 80Vdc, but only certain high voltage inverters can start with such low voltage.

**WeCo recommends operating for small scale ESS (up to 120 kWh) using the TYPE A HV BOX (80-750Vdc).**

**The typical Voltage HV Voltage is between 150 and 750Vdc however some inverter requires lower voltage ranges, so the TYPE A HV BOX is still suitable in the range 80~ 750Vdc).**

**For Commercial Scale applications the most common Voltage Range is between 150 and 1000Vdc this voltage ranges requires the TYPE B HV BOX (150~1000Vdc operative range).**

**Make sure the String Voltage does not exceed the inverter max Voltage to avoid major damages.**



#### ATTENTION:

The maximum number of modules that can be stacked is 8 on each tower (due to the tower height and stability) and the maximum number of modules composing an HV string must not exceed the HV BOX nominal input Voltage.

As a serial connection is possible to connect up to 12 modules in series distributed in two towers under the same HV BOX type A and up to 16 modules in serial connection under the HV BOX type B.

Before stacking the modules make sure the support surface is strong enough to support the weight, always consult a local civil engineer before installing.

## Warning Statements



### Lithium Iron Phosphate (LiFePO<sub>4</sub>) Battery or Cell DANGER

#### Hazard Statement

The materials contained in this product may only represent a hazard if the integrity of the cell or battery is compromised: physically, thermally, or electrically abused. The below are the hazards anticipated under those conditions: causes skin irritation; causes serious eye irritation; may cause an allergic skin reaction; causes damage to organs (bone, teeth) through prolonged or repeated exposure; very toxic to aquatic life; harmful to aquatic life with long lasting effects.

#### Precautionary Statement

##### Prevention

Do not breathe dust. Do not eat, drink or smoke when using this product. Wear protective gloves/protective clothing/eye protection/face protection. Wash thoroughly after handling. Contaminated work clothing must not be allowed out of the workplace. Avoid release to the environment, read the MSDS of the 5K3-XP model before installing.

##### Response

If on skin: wash with plenty of water. If skin irritation or rash occurs: get medical advice/attention. Take off contaminated clothing and wash it before reuse. If in eyes: rinse cautiously with water for several minutes; remove contact lenses, if present and easy to do; continue rinsing. If eye irritation persists: get medical advice/attention. Get medical advice/attention if you feel unwell. Collect spillage.

##### Storage

Store as indicated in the Storage section of this manual, do not exceed one year without an inspection via Bluetooth debug APP or via PC software to monitor the status of charge. Storage temperature affects the SoC retention, if your storage temperature is not within 15 and 30 degrees the self-discharge might be faster than 1-2% a month. Consider these factors in your storage strategies.

##### Disposal

Dispose of contents/container in accordance with local/regional/national/international regulations. Always contact a professional company to dismount and dispose the battery.

## Supplemental information

Under normal conditions of processing and use, exposure to the chemical constituents in this product is unlikely. The chemicals are contained in a sealed aluminum housing. Risk of exposure occurs only if the battery is mechanically, thermally or electrically abused. If this occurs, exposure to the electrolyte solution contained within can occur by inhalation, ingestion, eye contact and skin contact.

Additional Notes: CAUTION: Do not open or disassemble the battery. Do not dispose in fire, mix with other battery types, charge above specified rate, connect improperly, or short circuit, which may result in overheating, explosion or leakage of cell contents. Do not open or disassemble. Do not puncture, deform, incinerate or heat above 85°C /185°F. Keep away from heat/sparks/open flames/hot surfaces. - No smoking.

Do not wear metallic ornaments.

Always use protective personal devices and personal protections against electrical shocks, impacts and ejections.

This product is a "Hazardous Chemical" as defined by the OSHA Hazard Communication Standard.

Additional information is given in the Safety Data Sheet.

FOR NORTH AMERICA>Emergency Number USA/Canada: CHEMTREC (800) 424-9300, Outside USA 1 (703) 527-3887  
FOR EUROPE> Emergency Number for EUROPE/Africa/ASIA: Emergency: +39 055 0357960

## General Preparation

Before Installation:

- Ensure that all the modules are turned OFF.
- Ensure the enclosure is free from damages dents or any deformations caused by impacts.
- Battery installation location should be at least 20m away from sources of heat, protected from any source of sparks, free flames and any other sources of extreme temperature.
- Battery connecting cables shall be as short as possible to prevent excessive voltage drops.
- Battery installation must be away from any GAS, FUEL or any INFLAMMABLE GAS OR LIQUID. The internal contactor and electronic devices can cause internal sparks during the normal usage.
- Batteries with different capacity, different type/model or design or from different manufacturers shall not be connected together.

**Before connecting the battery, the battery positive and negative poles shall be carefully checked to ensure correct installation.**

**The installation location must be on a flat level surface, in a dry, clean and protected room, away from water and humidity.**



Even if the mechanical installation method for the WeCo 5K3-XP Battery Modules can be considered “conceptually” the same for HV and LV configurations, the operator must read this manual in full.

Before starting any operation on the battery, make sure to position the modules in their final position and structurally fix all the modules that make up the system on a previously verified surface.

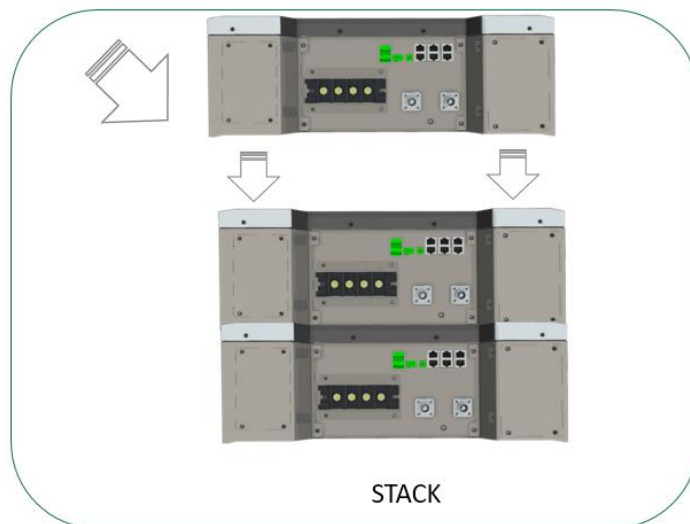

The wall mounted bracket is intended to be used only for low voltage applications.  
Stack Mounted configuration is suitable for both LV and HV configuration.

**The installer who intends to install the WeCo 5K3-XP Battery Module in the HV configuration should read this entire manual including the LV configuration information contained in this manual.**



**ATTENTION:**  
**STACKABLE INSTALLATION INFORMATION**

The stack configuration shall be concluded by interlocking the modules by using the module feet as shown below.

Always secure one module to another before completing the tower.

Loosen the feet and interlock the modules by installing the feet across the two modules and using the screws of each foot.



Use the two screws to fix the feet across the modules  
The screw holes are on the side of the battery

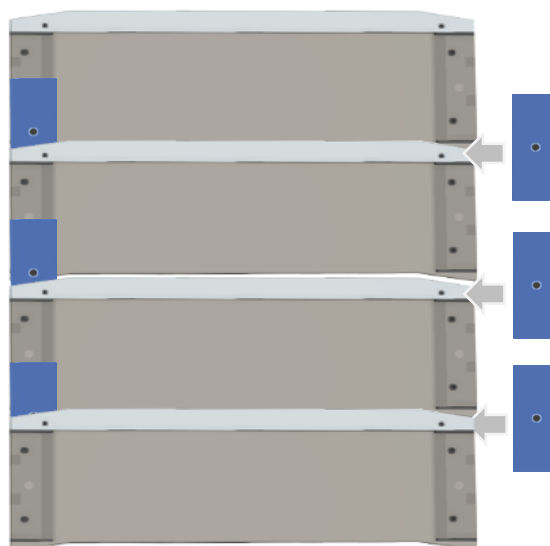
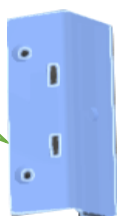

Install the feet across the modules



When operating in stack mode, remove the upper (trapezoidal) front part from the Battery Module to allow the cables to pass through.

The front plate must be reinstated to protect the cables after the installation is complete.



**ATTENTION:**

The WeCo 5K3-XP Battery Module has two terminals for connecting the power supply. The installer must pay the utmost attention to the respective functions.

LOW VOLTAGE

HIGH VOLTAGE

PARALLEL CONNECTION

SERIAL CONNECTION

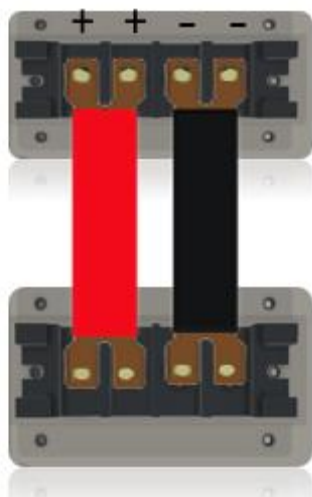

The low voltage screw terminal only supports parallel connection with maximum voltage 60V  
 CAUTION> Connecting these terminals in series will cause serious damage to the battery  
**DO NOT CONNECT IN SERIES**

Fast Connector terminals only support series connections up to 1000Vdc (always check the HV BOX max Voltage)  
 CAUTION> Connecting these terminals in parallel will cause serious damage to the battery  
**DO NOT CONNECT IN PARALLEL**

## SECTION 1 - STORAGE & PRE-OPERATIONAL PROCEDURES

### 1.1 Storage - Transportation – Removing / Relocation of Batteries

- ✓ This Battery is considered DANGEROUS GOODS by the United Nations and must be treated accordingly.
- ✓ Each box comes from the factory with the below labels:

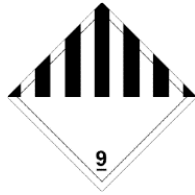

- ✓ This battery can only be transported and stored with the original approved carton box, Certified as per UN CLASS 9 Y80.
- ✓ This Battery must be stored in its original carton box in a dry and cool place. Carton box is marked as below:



- ✓ The transportation and Storage State of Charge (SoC) shall not exceed 50%.
- ✓ The shelf period without recharging is 3 months, then requires a charge up to 50% DoD and a discharge to the SoC required by law for storage conditions. If shipped by sea, you must refer to the UN38.3 standard. If by road, refer to local codes and regulations.
- ✓ To preserve the performance and shelf life, this battery should optimally be stored at 77°F /25°F and @70% humidity.
- ✓ Acceptable storage temperature range of the battery is between +59°F and +95°F /+15°C and +35°C.
- ✓ The self-discharge in the range of +59°F to +119°F /+15°C to +35°C is around 1% a month. Anything outside this range could exceed 10% a month.
- ✓ Do not store the batteries near sources of heat, vapor, gas, fuels, sparks or anything that could generate fire or explosion.
- ✓ Store inside and protect from water and moisture.
- ✓ Transportation of new and used or damaged modules must be in accordance with the UN 38.3 Regulation and with the Federal, State and Local regulations.
- ✓ If one or more working Battery Modules need to be removed or relocated, they must be marked as **USED BATTERY** (follow local rules).
- ✓ If one or more Battery Modules need to be replaced due to damage, they should be marked as **DAMAGED USED BATTERY** and follow any applicable procedures and all Federal, State and Local regulations.



The installer approaching this battery model for the first time must understand the use and operation of its accessories.

The 5K3-XP Battery Module can be equipped with an auxiliary combiner such as:

- **LOW VOLTAGE HUB** 5K3-XP for Low Voltage configurations up to 105 batteries (7-Clusters x 15-Modules).
- **HIGH VOLTAGE HUB** 5K3-XP device for High Voltage configurations up to 750Vdc per Cluster using the TYPE A HV BOX.

*Or up to 1000Vdc per cluster using the TYPE B HV BOX.*

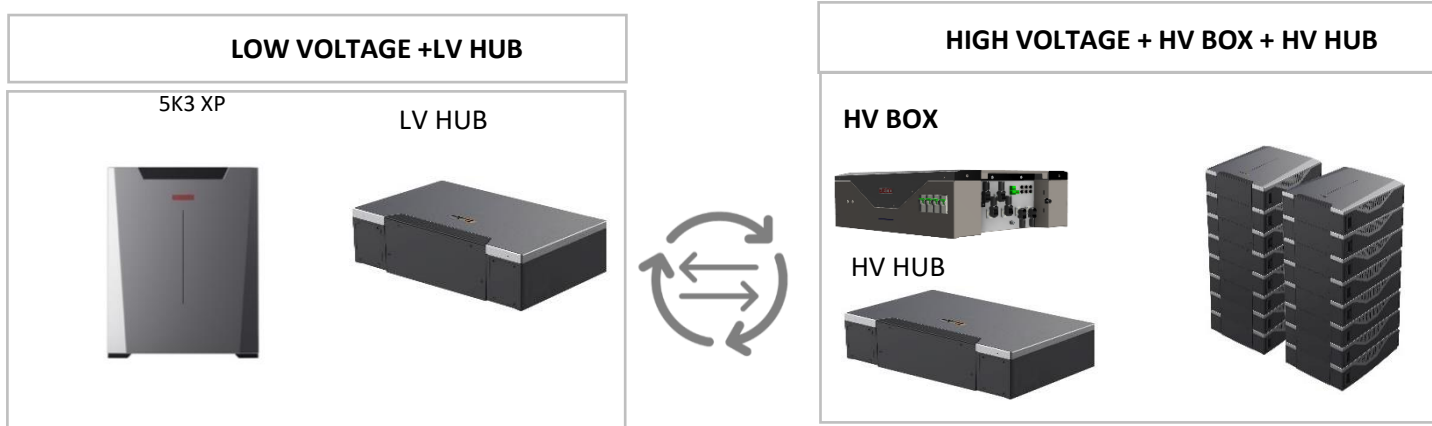

Each device or accessory of the 5K3-XP will have a specific Firmware that manages the logic and interconnection functions between Battery Modules and devices.

It is therefore important to understand the operational and interaction concepts of the 5K3-XP battery within a more complex system.



## 1.2 Module Unpacking and Handling

The battery is always delivered in WALL mode and it is therefore necessary for the installer to make simple changes to install the STACK kit. Below are the installation phases.



**ATTENTION:**

**The battery must be lifted by four persons, using the four handles.**

Two handles are built in and the other two are provided as temporary handles to be used as shown below.

Open the carton box, find the portable and retractable handles, position them and proceed with lifting.



**ATTENTION:**

**The support feet are designed to slide by slightly losing the holding screws, put the feet into position then tight again the screws by using an ALLEN key to secure the feet before lifting the battery.**

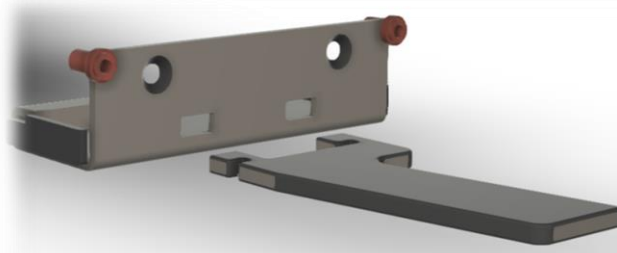
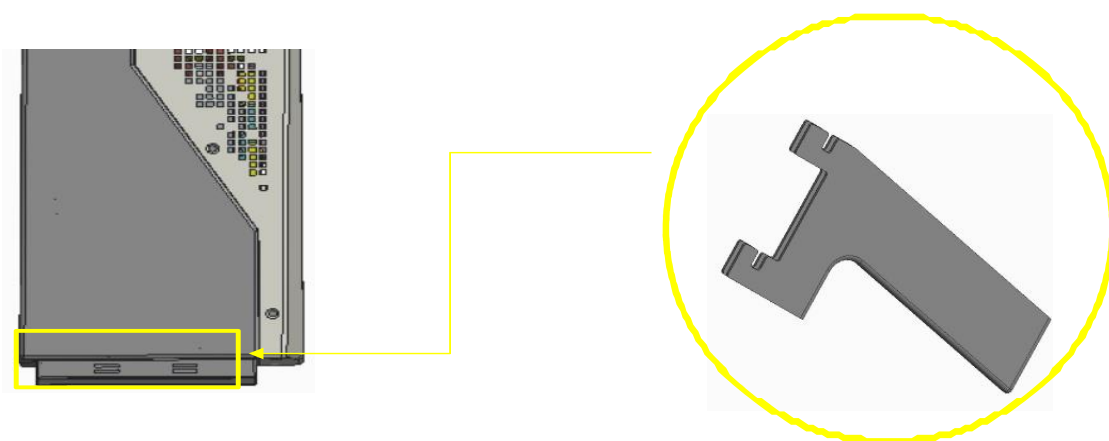

Interlock the handles inside the feet holes



### 1.2.1 Package Information and System Configuration List

The battery Module is packed in cartons with accessories.

Upon receipt, review the configuration list carefully to make sure that the battery module and accessories are received in the correct quantities and type and visually inspect to ensure that they are free from damage.

Refer to Section 2.1.3 for Low Voltage packing list and to Section 3.1.3 for High Voltage packing list.

If battery is damaged and/or components missing, contact your local WeCo representative.

## 1.3 Wall Mount or Stack Mount Configuration



**NOTE:** The WeCo 5K3-XP Battery Module is shipped as standard in the wall mount configuration (in some Countries the wall mounted kit is not included and needs to be ordered separately).

### 1.3.1 Battery Dimensions\* (Wall Bracket)

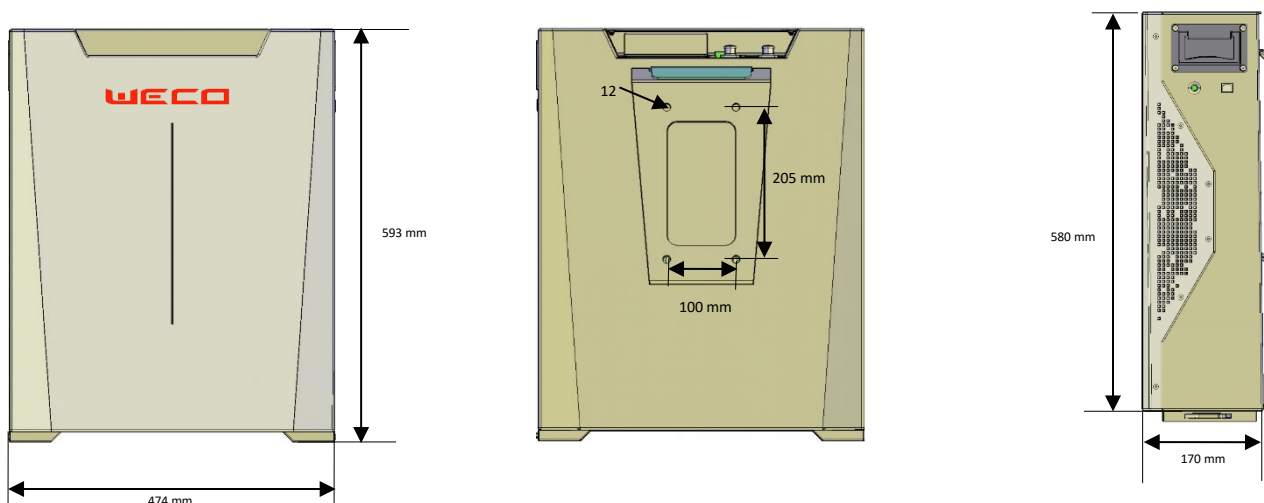

\*Dimensions are subject to construction tolerance +/- 1%

### 1.3.2 Wall Mount

Step 1: Install the wall bracket by using the wall plugs and screws contained in the battery kit.

The wall must be inspected before proceeding with the bracket installation. A local civil engineer should assess the correct installation method, either wall or floor mounted.

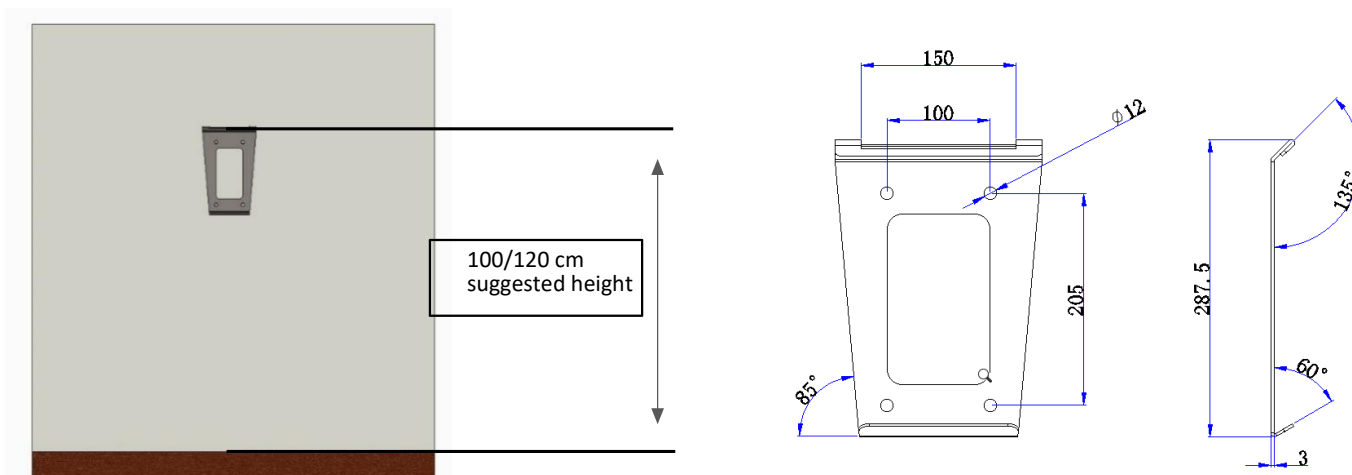



**ATTENTION:**

The Battery Module weighs 119 lb (54 kg) and must be installed with the help of a mechanical lift, and/or by four people equipped with suitable suction cups for mechanical lifting or lifting straps.

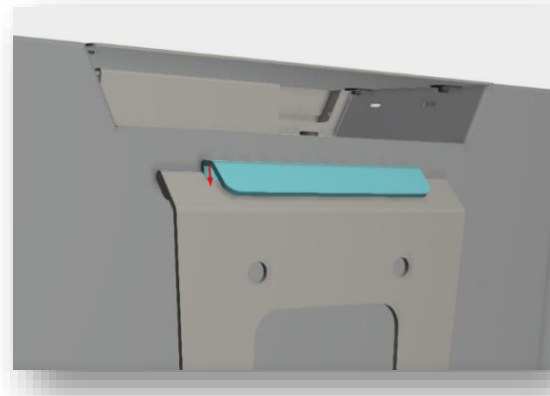
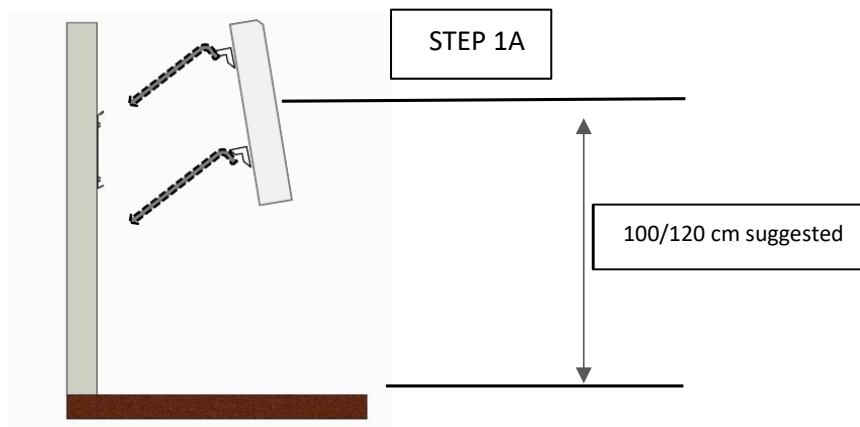

The Bracket must be installed on a flat and vertical wall capable to support the weight of the battery.

The steel bracket must be flush to the wall without any empty spaces between the wall surface and the back side of the bracket.

Make sure to have adequate space to install the battery before proceeding with the installation.

Step 2: Install the battery by fitting the back bracket of the module with the wall bracket interlocking.

This operation must be conducted with a mechanical lifting device and/or with at least four specialized installers.

Make sure the Battery Module is stable and properly locked into the upper interlocking plug.

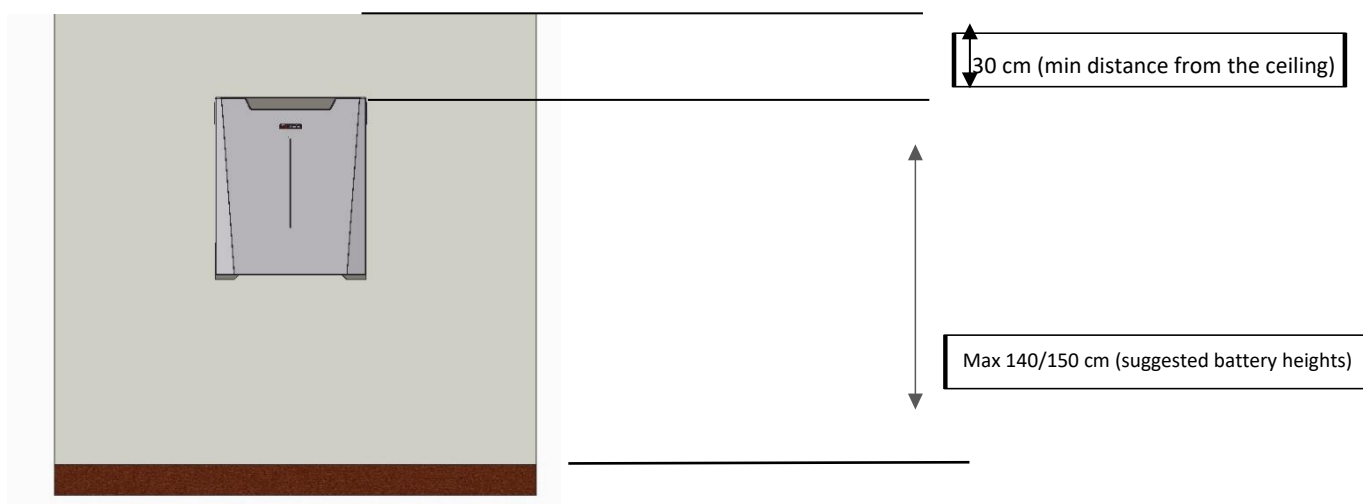

Step 2A: In case of multiple module installations, make sure to respect the distance between the modules and the ceiling.

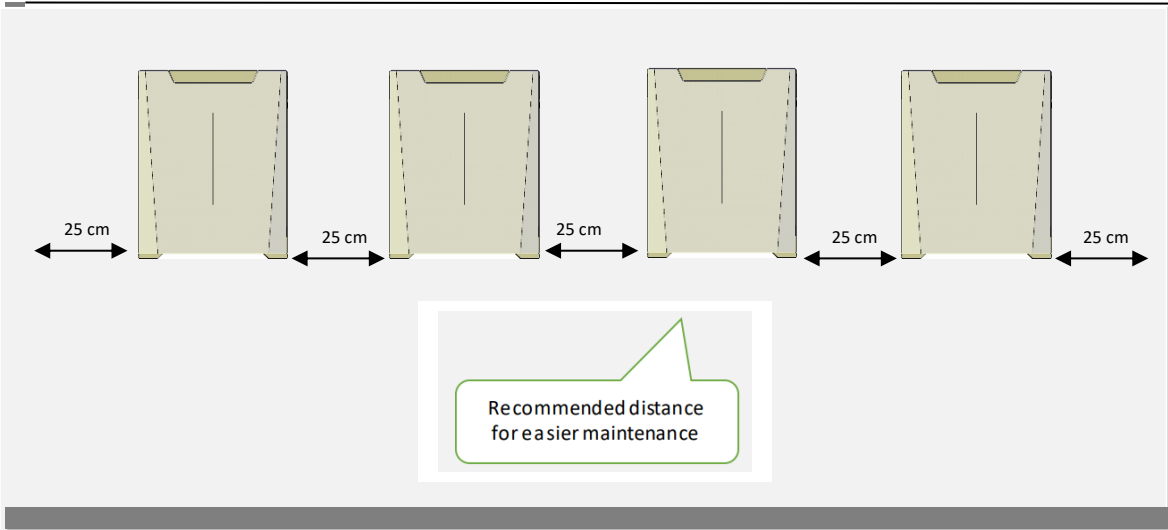

Example of a Floor or Wall Mounted battery cluster connected with power cables and data cables.

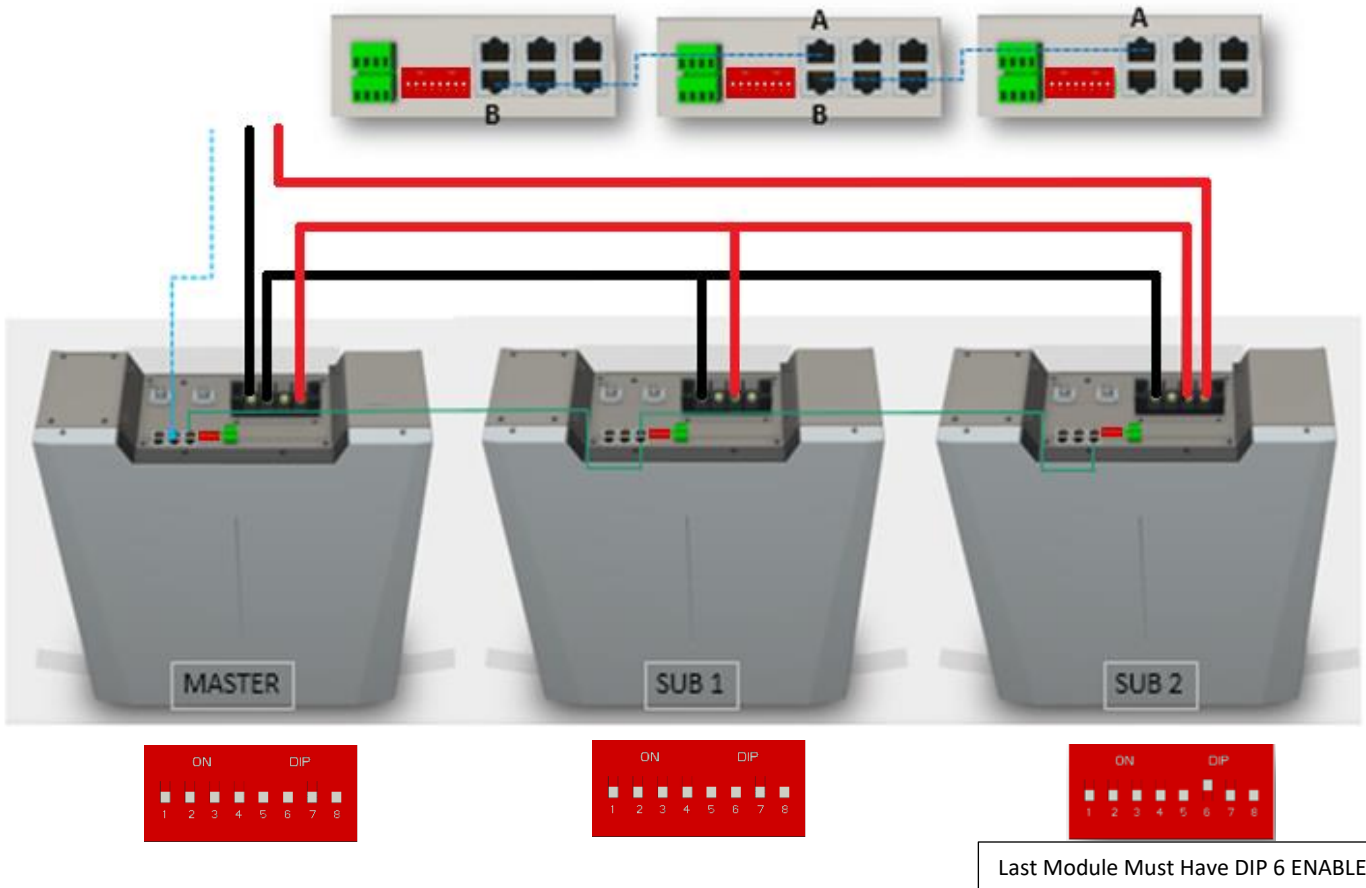

Note: In a single cluster configuration, there is no need to set the DIP switch on the master battery.

All DIP switches should be set to OFF with the only exception being the last module which must have the terminator enabled, namely DIP6 set to ON (120 Ohm Resistor).

Examples of a Floor or Wall Mounted battery cluster.

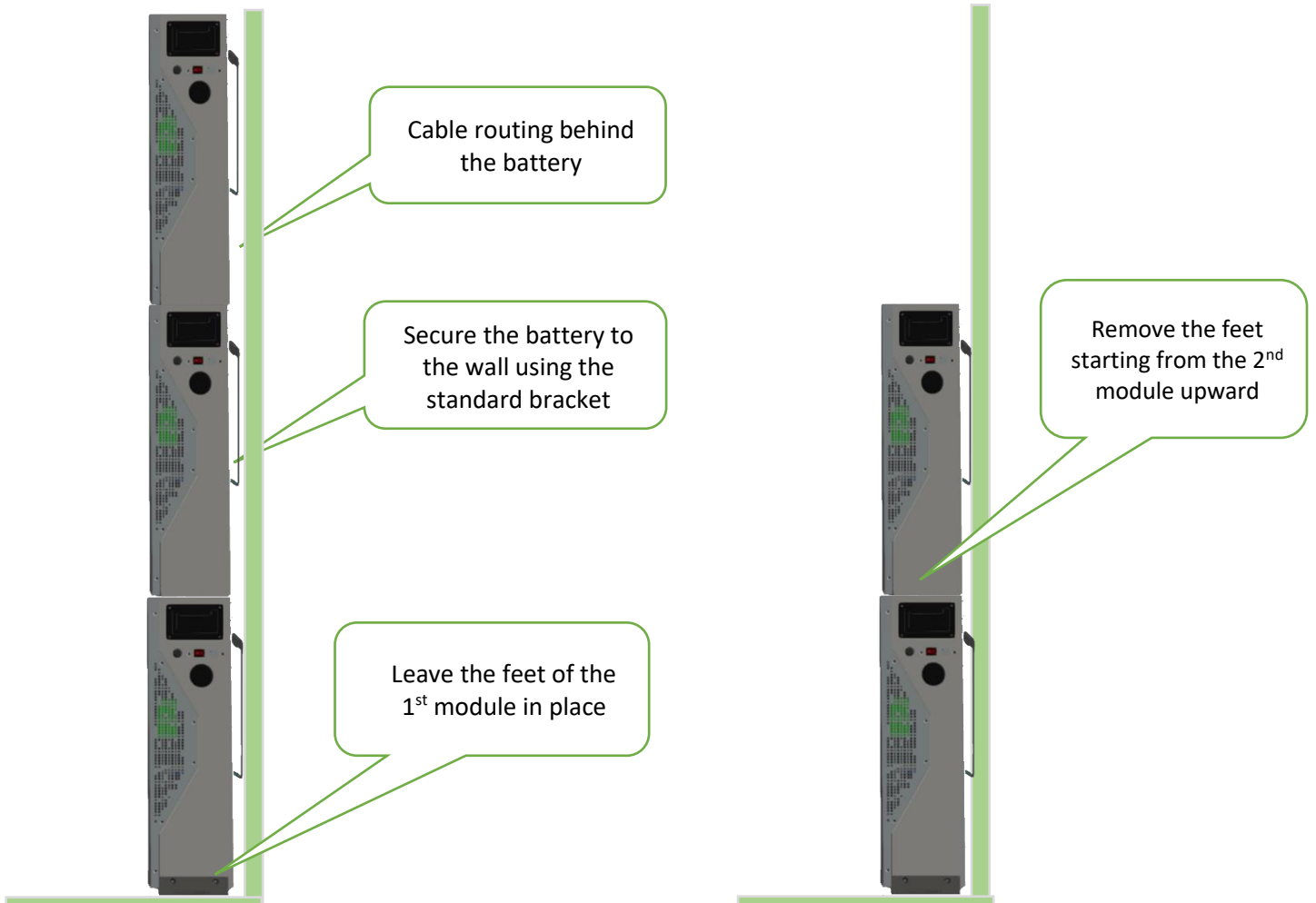

### 1.3.3 Stack Mount



**ATTENTION:**

The Battery Module weighs 119 lb /54 kg (weight might vary according with the connection kit chosen) and must be installed with the help of a mechanical lift or by four people equipped with suitable suction cups for mechanical lifting or lifting straps.

As previously stated in this manual, the 5K3-XP Battery Module comes with the wall mount kit as standard kit. The Connection Kits or Cables Kits for LV or HV application may vary Country by Country, make sure to ask the right accessories.

To install in the Stackable configuration, the screws and brackets on the back of the battery module must be removed (if installed).

1. Remove the back-side wall support plate using an Allen Key. The plate has five screws.

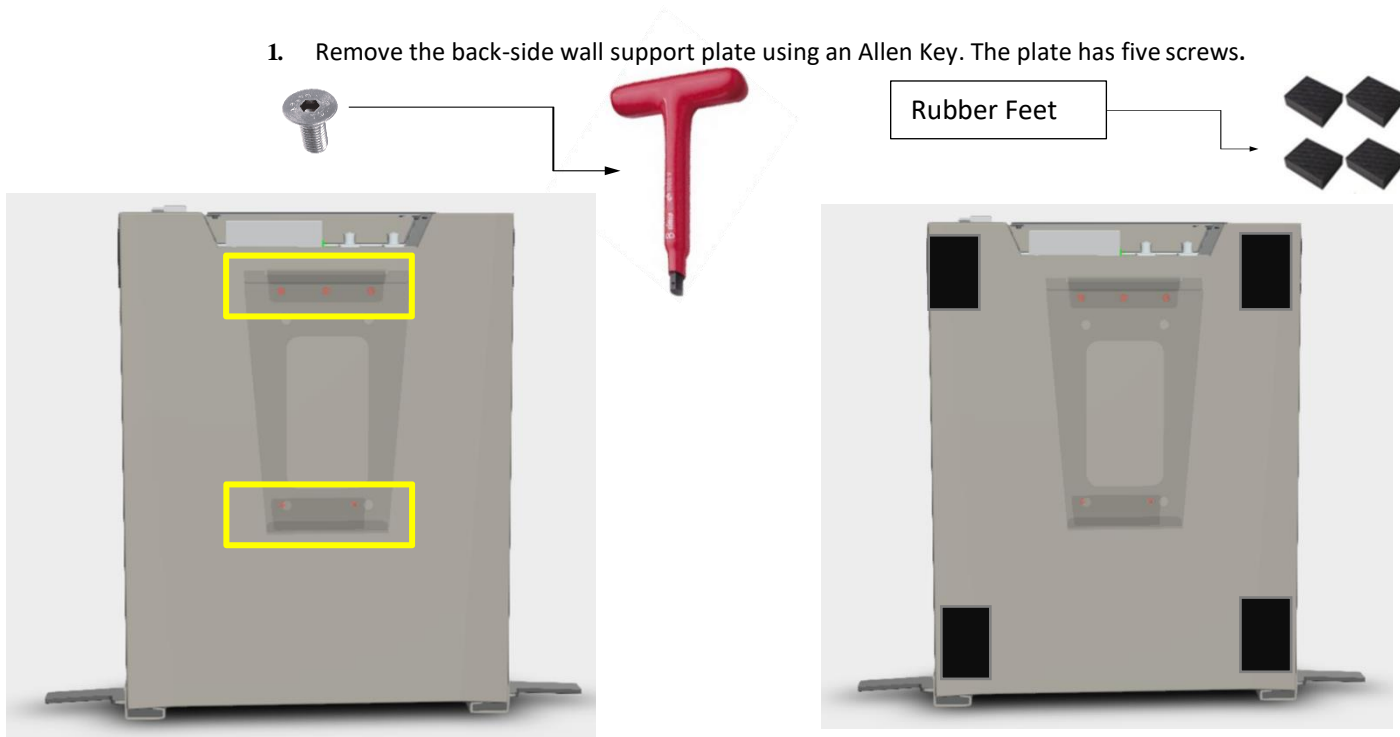

2. Once the wall bracket support has been removed, start stacking the second module on top of the first module laid on the ground by using the handles.

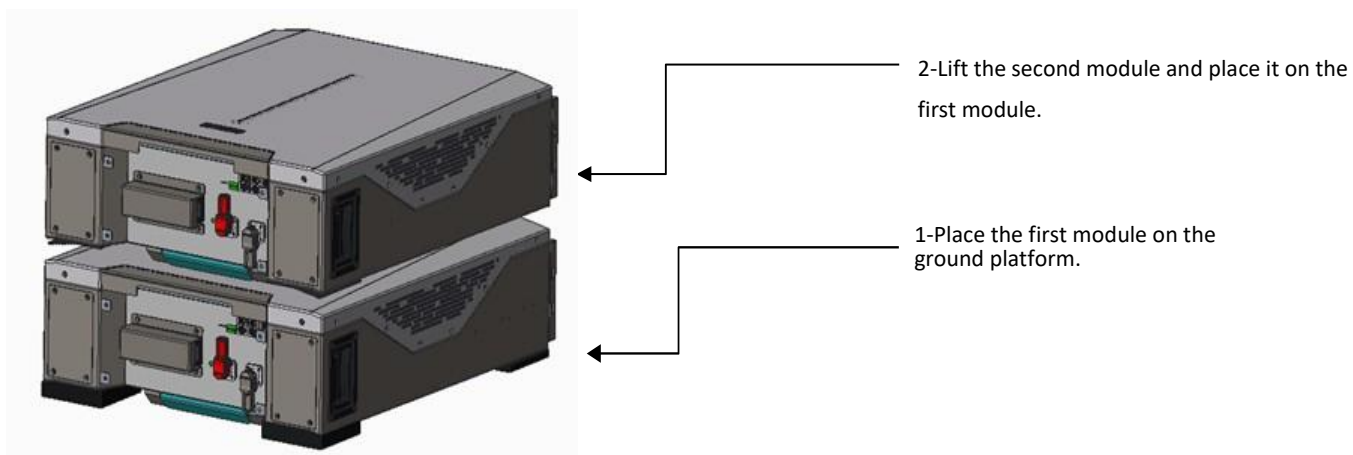



**ATTENTION:**

Before stacking the batteries, the installer must check the maximum permissible floor load. It is recommended that the installer obtains approval from a civil engineer.

For ground mounting, the support surface of the Battery Module is distributed on 4 insulated supports (rubber pads), 8 x 4 cm each (dimensions of the rubber could be different Country by Country). A civil engineer must vary the foundation/floor admissible load and ensure that the weight can be supported.

When the batteries are installed over the wall make sure the wall can support the batteries weight.

Consider the seismic effect on the structures, consult a local civil engineer.

In case of horizontal installation, the installer must prepare an adequate distribution plate on the floor in order to make a safe and stable support for the battery stack.



**ATTENTION:**

Ensure the support and/or the floor surface is adequate to support the battery load.

WeCo Suggest limiting the stack to 5 modules however you can stack up to 8 if the support base/floor can support the load of the stacked cluster of 5k3 XP.

It is mandatory to interlock the batteries together and fix the cluster to the wall.

Do not stack more than eight modules to avoid structural damages on the battery case.

In case seismic area please ensure the cluster on vertical structure. Consult with a local civil engineer.

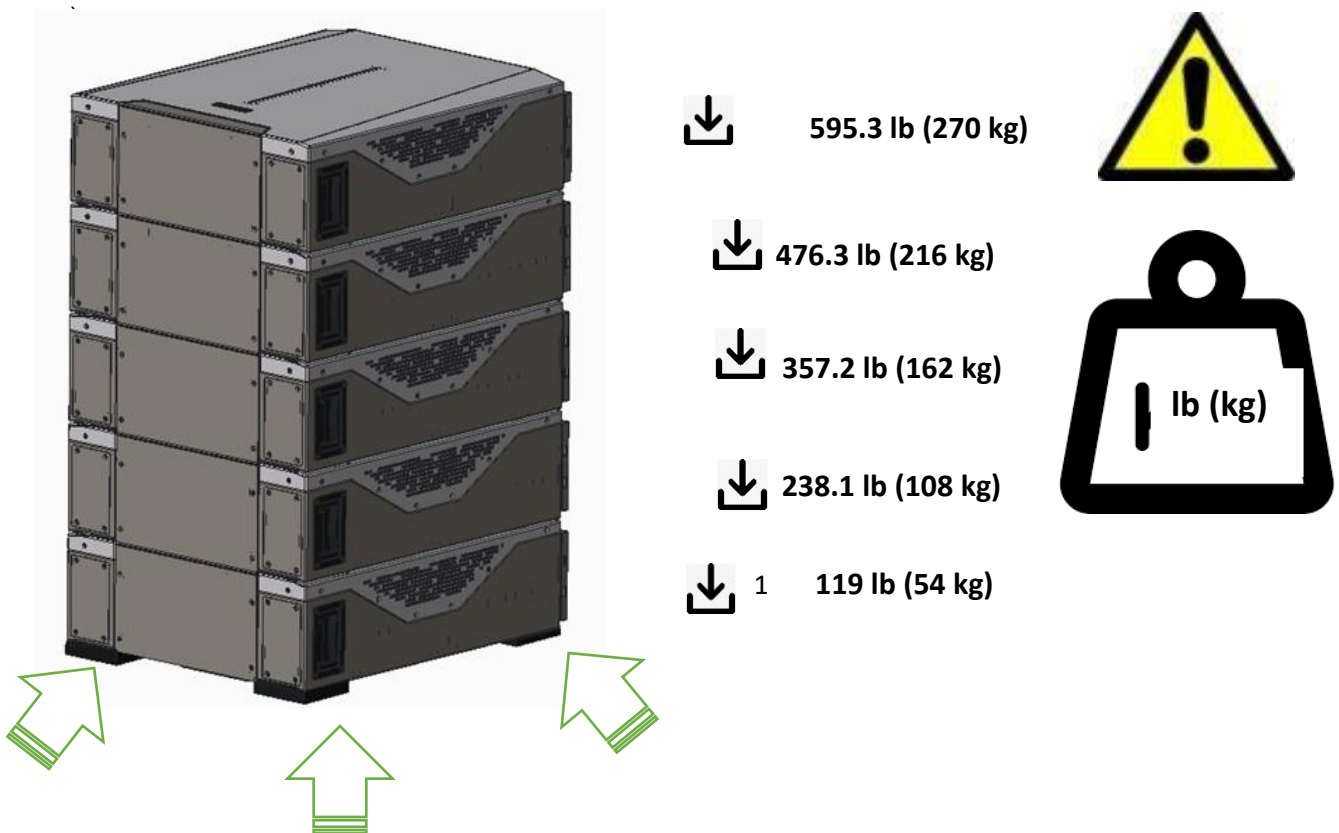

### 1.4 Battery Terminal Function Definition

The terminal layout is shown in the following figure:

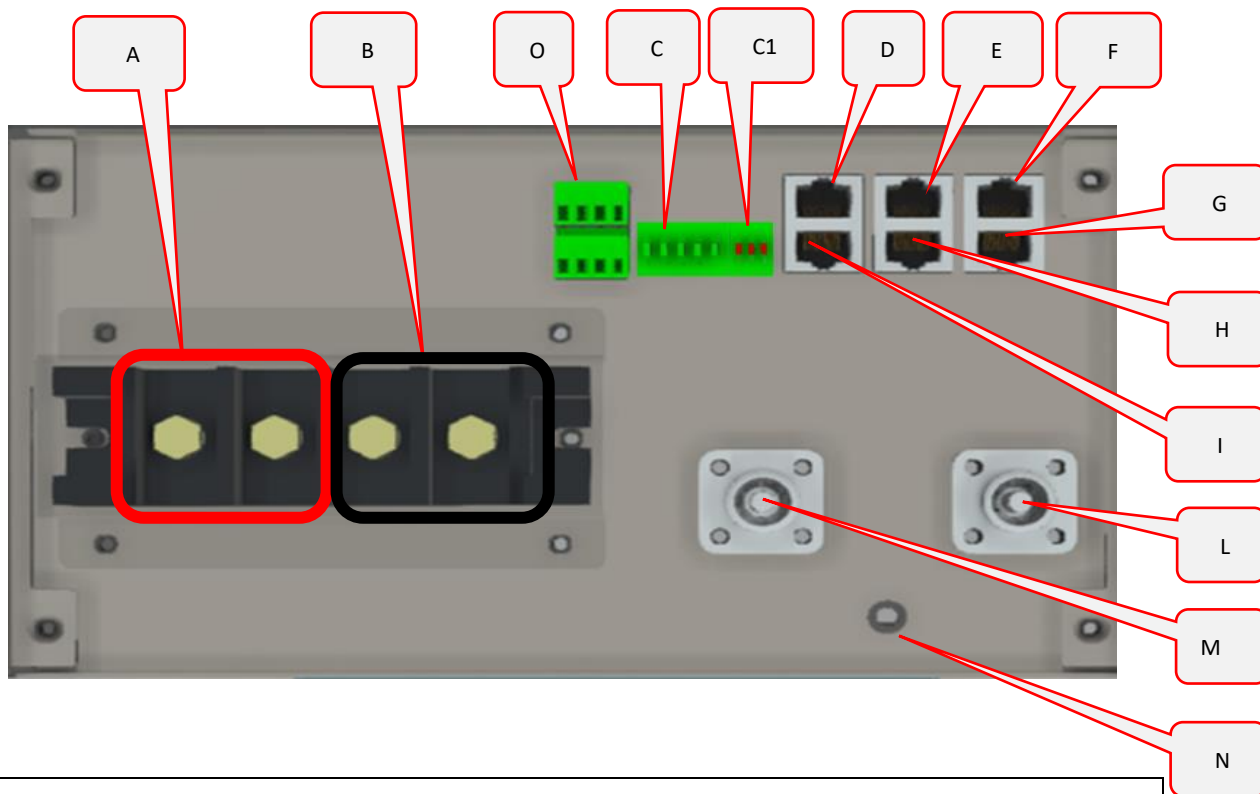

Interface	Name	Function
A	LV POLE +	LOW VOLTAGE POSITIVE (+) Screw Terminal (9,5 Nm Fixing Torque Max)
B	LV POLE -	LOW VOLTAGE NEGATIVE (-) Screw Terminal (9,5 Nm Fixing Torque Max)
C	DIP SWITCH	DIP SWITCH Address HUB 5 PINS
C1	DIP SWITCH	DIP SWITCH Termination 3 PINS (120 Ohms)
D	RS485 A	LOW VOLTAGE COMMUNICATION PORT RS485
E	CAN A	CAN – BMS to LOW VOLTAGE INVERTER (OR HV SERIAL CONNECTION)
F	LINK	OPERATOR PORT/RS232
G	LINK	LINK PORT FOR LVHV COMPATIBILIY
H	CAN B	HIGH VOLTAGE SERIAL RJ45 CAN PORT
I	RS485 B	LOW VOLTAGE COMMUNICATION PORT RS485
L	HV POLE -	HIGH VOLTAGE NEGATIVE (-) Fast Connector Terminal for serial connection
M	HV POLE +	HIGH VOLTAGE POSITIVE (+) Fast Connector Terminal for serial connection
N	GND	Ground Terminal (3Nm fixing Torque Max)
O	DRY CONTACTS	Digital input and output

**Attention:** Interface E: RJ45 port corresponding to the CAN bus pin definition

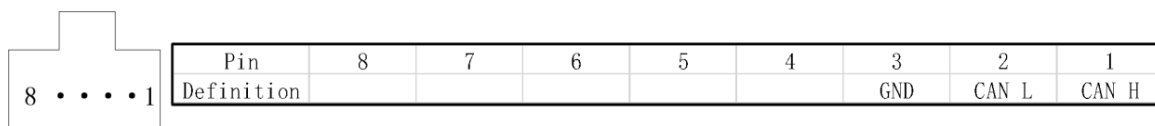

## 1.5 Out of the Box Pre-Operational Check

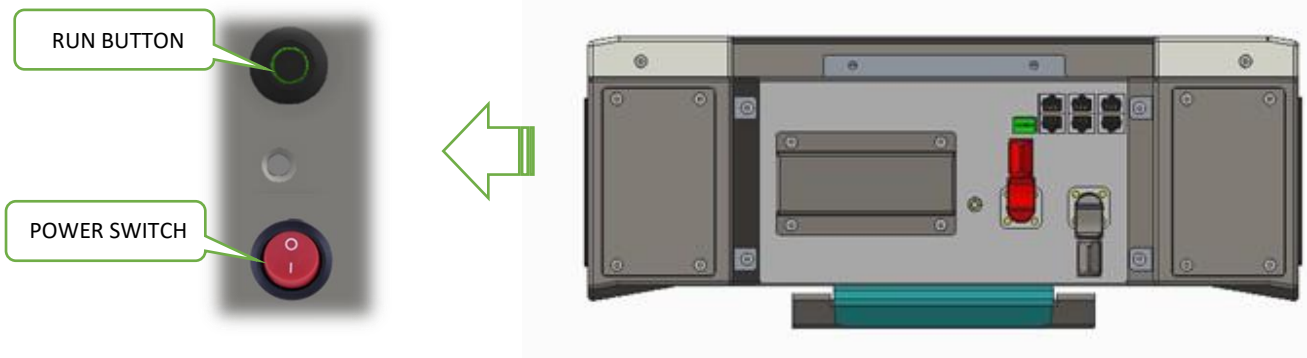

### Attention:

Do not make any connection to the Battery Module until you have thoroughly read and understood this entire manual.

The Run Button and the Power Switch are located on the left side of the Battery Module as shown above.

The Power Switch is a mechanical ON/OFF switch that enables/disables the power supply of the BMS.

Set the Power Switch to ON (1) to start activation of the battery power supply, Set to OFF (0) to shut down completely.

The Run Button is a GREEN LED button that when pressed for 2 seconds will initiate the startup process of the battery.

Pressing the Run Button for 5 seconds will shut down the battery (the BMS will remain powered).

The Run Button will settle as a steady GREEN color if the battery is operating correctly. If the battery is low on charge, the Run Button will blink GREEN.

In the event of a RED blinking alarm on the LED bar, it is required to inspect the system settings before attempting a new restart, following the steps in the manual.

If the LED bar is all illuminated in RED, there is a major fault and you should not attempt any further operation of the battery. Contact WeCo support at [service@wecobatteries.com](mailto:service@wecobatteries.com).

There is an RS232 Operator Port which will allow you to check all parameters of the Battery Module. Full instructions on how to interface to the RS232 port can be found in this manual.

**ATTENTION:**  
Before operating, make sure that the voltage is 0 Vdc.  
The battery must be turned off before starting any activity.

**ATTENTION:**  
The HV terminals are always live as the internal circuit of the battery is not interrupted by a switch or MOSFET for series connection.

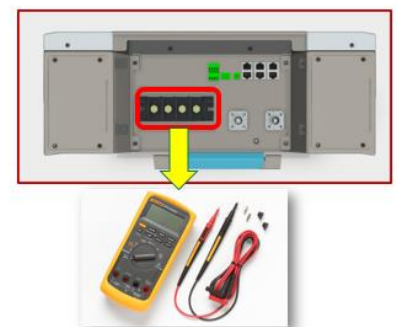

### Attention:

At this stage, after you have determined that the battery is functioning correctly, it is mandatory to switch the battery off and follow the instructions and guidance in this manual very carefully before attempting any configuration or connection to the Battery Module.

To switch the battery off (shutdown the battery), simply press the Run Button for 5-seconds and the GREEN LED light will go off, confirming that the Battery Module has shutdown correctly.



### Attention:

Read this manual thoroughly, and always follow the guidance herein before and while performing any installation procedure.

## SECTION 2 - LOW VOLTAGE CONFIGURATION

### 2.1 Product Introduction

The WeCo 5K3-XP Battery Modules can be used as an on-grid or off-grid energy storage system. It is not allowed to use this product for any purpose other than the intended purpose as described in this document.

Use of this product other than as described in this document will nullify the product warranty.

The substitution of any components of this Battery Module will nullify the product warranty.

The use of any components contained within or connected to this Battery Module other than the products sold as part of this product or recommended by the manufacturer will nullify the product warranty.

Connecting more than eight WeCo 5K3-XP Battery Modules in stack will nullify the product warranty.

#### 2.1.1 Identifying the Individual Module

The below values are not part of the performance warranty threshold.

Dimensions	mm	580x474x170
Weight	lb (kg)	119 lb (54kg)
Case Material	Type	Steel
Parallel Modules	Max No.	15
Stackable	Type	Yes
Digital Output	No.	2+2
Cell Distribution	P/S	16S

\*Other variables can be introduced by the BMS

Cell type	Type	LiFePO4
<b>BMS Charge extreme Temp</b>	°F (°C)	<b>+19.4°F to +131°F* (-10°C to +55°C*)</b>
<b>BMS Discharge extreme Temp</b>	°F (°C)	<b>+131°F to -4°F* (+55°C to -20°C*)</b>
Reccoemnded Usage and Storage Temp	°F (°C)	+77°F (+25°C)
Storage Temp/Time outside the suggested storage temperature	°F (°C)	-13°F to +131°F / 3 months (-25°C to +55°C / 3 months)
Self-Discharge @ 77°F (25°C)	%	1% per month
Self-Discharge outside the STC	%	> 3% per month

### Product Identification and labels

The nameplate label describes the product parameters and is attached to the product. For details, please refer to the nameplate label of the product. For safety reasons, the installer must have a thorough understanding of the contents of this manual before installing the product.

The label data may be different from the manual, always refer to the label of the product you have purchased.

#### WeCo BATTERY MODULE – PRODUCT LABEL









**2.1.2 Accessory list Low Voltage Kit (To be ordered separately).**

The Battery Module is packed in a carton together with accessories when ordered.

When unpacking the Battery Module, be sure to check that the Battery Module and accessories are free from damage and that the correct quantities of each component are included within the carton in accordance with the purchase agreement in your country.

The following list of components can be used as a checklist when unpacking the individual Battery Module and battery kits.

Cable Color	Cable Size	Cable Length	QTY	Description	Image
BLACK	25mm2	250cm	N° 1	Both sides ring terminal 8mm diameter for LV connection <b>Required for LV installation</b>	
RED	25mm2	250cm	N° 1	Both sides ring terminal 8mm diameter for LV connection <b>Required for LV installation</b>	
BLUE	CAT 5	150cm	N° 1	RJ45-RJ45 LV PARALLEL CABLE <b>Required for LV installation</b>	
BLUE	CAT 5	250cm	N° 1	RJ45-RJ9 CABLE BMS to inverter <b>Required for LV installation</b>	
WALL BRACKET			N° 1 Set	Wall plate for battery support + 4*M10 Wall Plugs + Screws	
BATTERY BRACKETS			N° 1 Set	Set of 2 brackets for wall installation + M6 screws (Allen key)	











**INFORMATION**

All CAN and RS485 communication cables are of the T568B type  
The CAN / BMS communication cable between the battery and inverter varies according to the inverter model.

The battery side must be kept in the original configuration while the inverter side must be **modified according to the inverter manufacturer's instructions.**

### 2.1.3 Necessary Installation Tools

 <p>Multimeter + Current clamp</p>	 <p>Insulated Screwdriver Set</p>	 <p>Insulated Allen Key Set from 2 mm to 8 mm</p>	 <p>Drill + Hammer</p>
 <p>Electrician Scissors</p>	 <p>Insulated Torque Wrench Set</p>	 <p>Lifting Strap + Mechanical Lifter</p>	 <p>RS232/USB + Screw Terminal (insulated)</p>

### 2.1.4 Personal Protective Equipment +1000 Vdc Insulated Tools



L  
O  
W  
  
V  
O  
L  
T  
A  
G  
E

## 2.2 Low Voltage Module Wiring and Set Up

### 2.2.1 Battery Connection Terminals

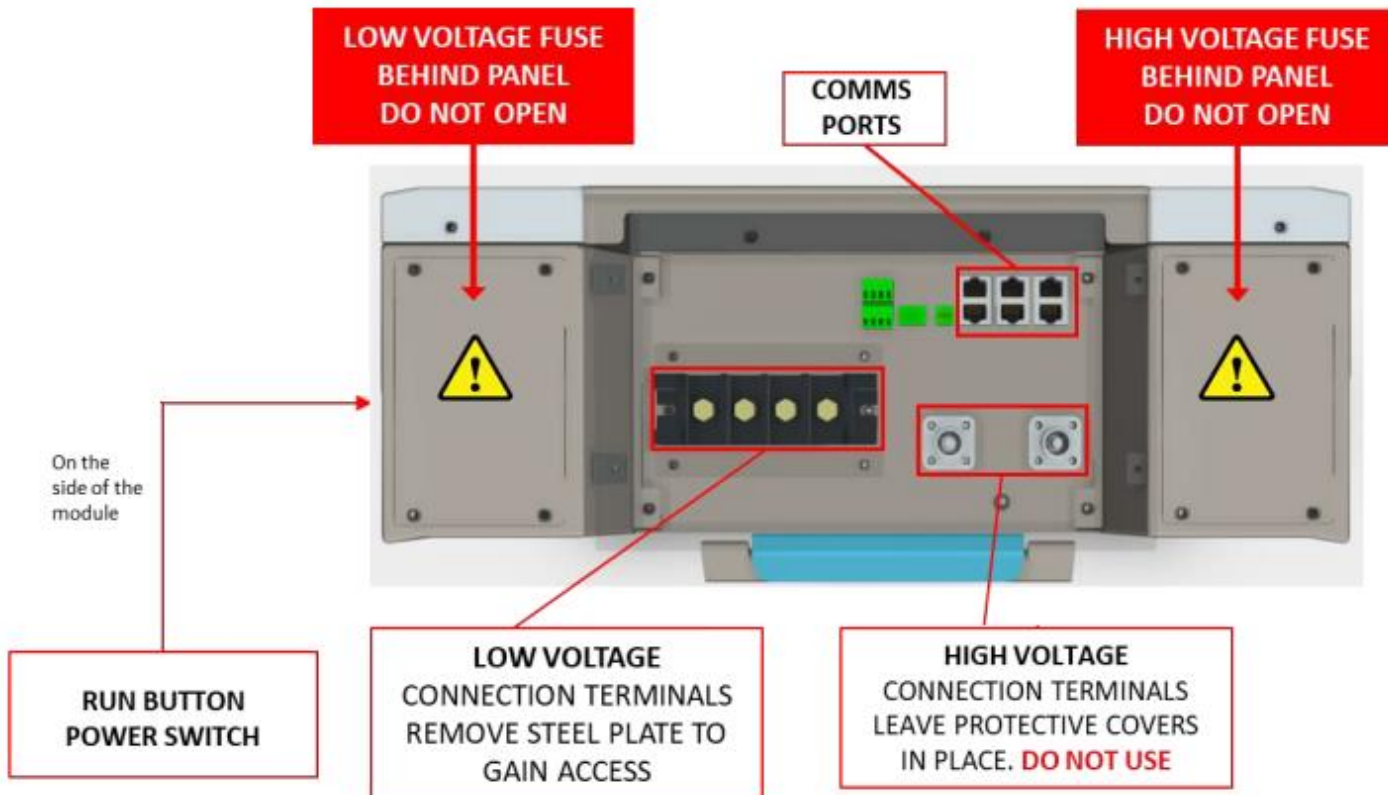

**CAUTION:** The LV fuse is contained in the left portion of the Battery Module as shown above. The access to the fuse is restricted to authorized WeCo service personnel and the protection lid cannot be opened by anyone else. The same applies to the HV fuse.

### 2.2.2 BATTERY CAN Pin Out

The terminal layout is shown in the following figure:

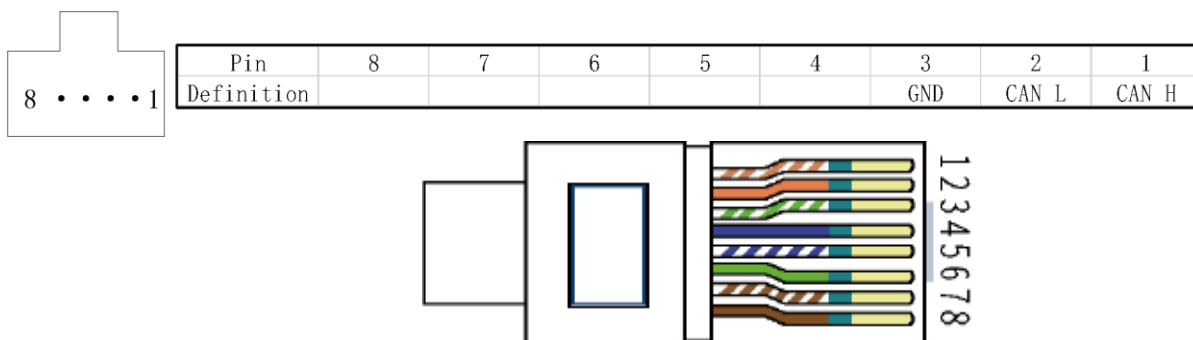

## 2.3 Low Voltage DIP Switch Settings



### ATTENTION:



ALWAYS CONFIGURE THE DIP SWITCH SETTINGS BEFORE CONNECTING ANY POWER CABLES TO THE BATTERY TERMINALS B+ AND B-.



WHEN CHANGES HAVE BEEN MADE TO DIP SWITCH SETTINGS, THE BATTERIES MUST ALWAYS BE RESTARTED FOR THE CHANGES TO TAKE EFFECT.



POWER CABLE CONNECTIONS MUST BE MADE IN STRICT ACCORDANCE WITH THE INSTRUCTIONS IN THIS MANUAL. INCORRECT POWER CONNECTIONS CAN DAMAGE THE BATTERY MODULE AND CAUSE INJURIES.



### **ATTENTION:**

**All drawings and images are for reference only.  
Always refer to the physical product as the standard.  
If the manual does not match the physical product, stop all actions, remove any connections, and  
store them in a safe place.  
Call your WeCo technical service representative for assistance.**

### 2.3.1 LOW VOLTAGE PARALLEL CONFIGURATION

The DIP switch must be set as follows to allow a single Battery Module to communicate with an inverter using CAN communications:



#### DIP CONFIGURATION UP TO FIFTEEN MODULES IN PARALLEL

From the 1<sup>st</sup> to the last module (or 15<sup>th</sup>) for a SINGLE CLUSTER in Low Voltage Configuration, the DIP setting of each battery must be set as per the picture below:



For Single cluster Configuration\*



When multiple modules are connected in Parallel, the last one must have the DIP 6 enabled\*\*

*\*DIP Switch settings for multiple clusters are covered in a separate section of this manual.*

*\*\* The DIP 6 acts as a terminator and must be enabled when more than one module is connected in parallel.*

### 2.3.2 LED Visual Indication Lights

There are three sources of visual indications on the Battery Module:

- POWER SWITCH ON/OFF
- RUN BUTTON GREEN LED
- SIDE LED BAR Multi Color

## 2.4 Module Activation and Shutdown

### START UP PROCEDURE

The Power Switch and Run Button are located to the right of the battery terminal connections on the side of the battery chassis. The Power Switch is a mechanical switch that switches the battery ON or OFF. The Run Button is an LED button that is only enabled when the Power Switch is in the ON (1) position. The Run Button provides several status indications that are described in the table below.



Name	Meaning	Function or Indication Status
POWER SWITCH	On/Off Button	Switches the Battery Module on and off.
RUN BUTTON	Module Correct Operation	When the Battery Module is running normally, indicator light will be STEADY GREEN.
LOW BATTERY	Low SOC	When the battery SoC is low (SoC<0-5%) the RUN Button will blink in a GREEN color at 1 second intervals. The RUN Button will stop blinking and turn STEADY GREEN when the battery is in charging mode and the SoC reaches 10%.
FRONT LED BAR	Fault indicator light (See Section 2.5.5)	When there is a fault with the Battery, the front LED BAR will show a full RED LED LIGHT and the RUN BUTTON will show no light within 10 seconds from the event.

**POWER ON:** Turn ON the Power Switch (1 = ON 0= OFF)

A 2-second press on the Run Button will turn the Battery Module on.

During the startup procedure, the Run button will blink until the safety inspection has been completed by the BMS.

In case of cluster, after the master is turned on the slave modules will automatically start up in sequence.

**SHUTDOWN:** A 5-second press and hold on the Run Button will turn the Battery Module off.

Turn OFF the Power Switch (1 = ON 0= OFF).

In case of cluster, wait for the total shut down (around 60 sec. each module) or manually press the RUN button of each module (5 seconds) and then set the main switch in OFF (Zero position).

Other functions of the Run Button are explained in the relevant sections of this manual.



**Attention:** Read this entire manual thoroughly to understand the correct startup and shutdown procedures for each battery configuration.

### POWER SWITCH

For a complete shutdown of the Battery Module (Master or Slave) press the Run Button for 5 seconds and then set the Power Switch to the OFF (0) position.

**ATTENTION:**



ALWAYS CONFIGURE THE DIP SWITCH SETTINGS IN ACCORDANCE WITH THIS MANUAL **BEFORE** CONNECTING ANY POWER CABLES TO THE BATTERY TERMINALS B+ AND B-.



WHEN CHANGES HAVE BEEN MADE TO THE DIP SWITCH SETTINGS, THE BATTERIES MUST ALWAYS BE RESTARTED FOR THE CHANGES TO TAKE EFFECT.



POWER CABLE CONNECTIONS MUST BE MADE IN STRICT ACCORDANCE WITH THE INSTRUCTIONS IN THIS MANUAL. INCORRECT POWER CONNECTIONS CAN DAMAGE THE BATTERY MODULE AND CAUSE INJURIES.



WHEN THE INVERTER HAS A CANBUS COMMUNICATION PORT, THE SWITCH OF THE MASTER BATTERY MUST ALWAYS BE SET TO "ON."



**ATTENTION:** All drawings are for reference only. Always refer to the physical product as the standard. If the manual does not match the physical product, stop all actions, remove any connections and store the batteries in a safe place. Call your WeCo technical service representative for assistance.

**2.5 Low Voltage Parallel Set Up Overview**

5K3-XP can be connected in parallel up to 15 modules, this process requires a full knowledge of the product.

**DIP Configuration for LOW Voltage Parallel**



**CAUTION:**

For a single cluster installation, it is necessary that the DIP switches of the batteries are set as below.

**All switches are set to "OFF"**



with the only exception of **the last module that must have the DIP 6 Enabled to activate the Terminator Resistance** (See below)



**After setting the DIP Switch, the Battery Module must be restarted for the DIP switch changes to take effect.**

- Once the DIP Switches of the single cluster have been set, it will be possible to perform the connection of the earth terminal between the modules and the general earth rod and subsequently it will be possible to connect the RS485 B Port of the Master battery with the RS 485 A Port of the SUB-1 battery using the RJ45 cable supplied.
- Continue to connect the RS485 ports in sequence (Port-B to Port-A.... Port-B to Port-A) up to the last module.
- Set the Power Switches on all batteries to the ON (1) position.
- Press the RUN BUTTON of the MASTER ONLY to initiate the cluster automatic start up. There is NO NEED to press any of the Sub Module Run Buttons as they will be configured automatically when the Master Run Button is pressed.
- Wait until the Run Buttons on all modules are a STEADY GREEN.

Switch off all batteries of cluster and proceed with the power connections using the cables or BUS BAR (accessory) if you are installing in stackable mode. Make sure alle the batteries are turned off before connecting cables.

The connection between the INVERTER and the MASTER / LAST MODULE must be performed using cables.

**DIP SWITCH TO BE SET 00000000 WHEN THE BATTERY IS OFF THAN NEED TO RESTART THE BATTERY**

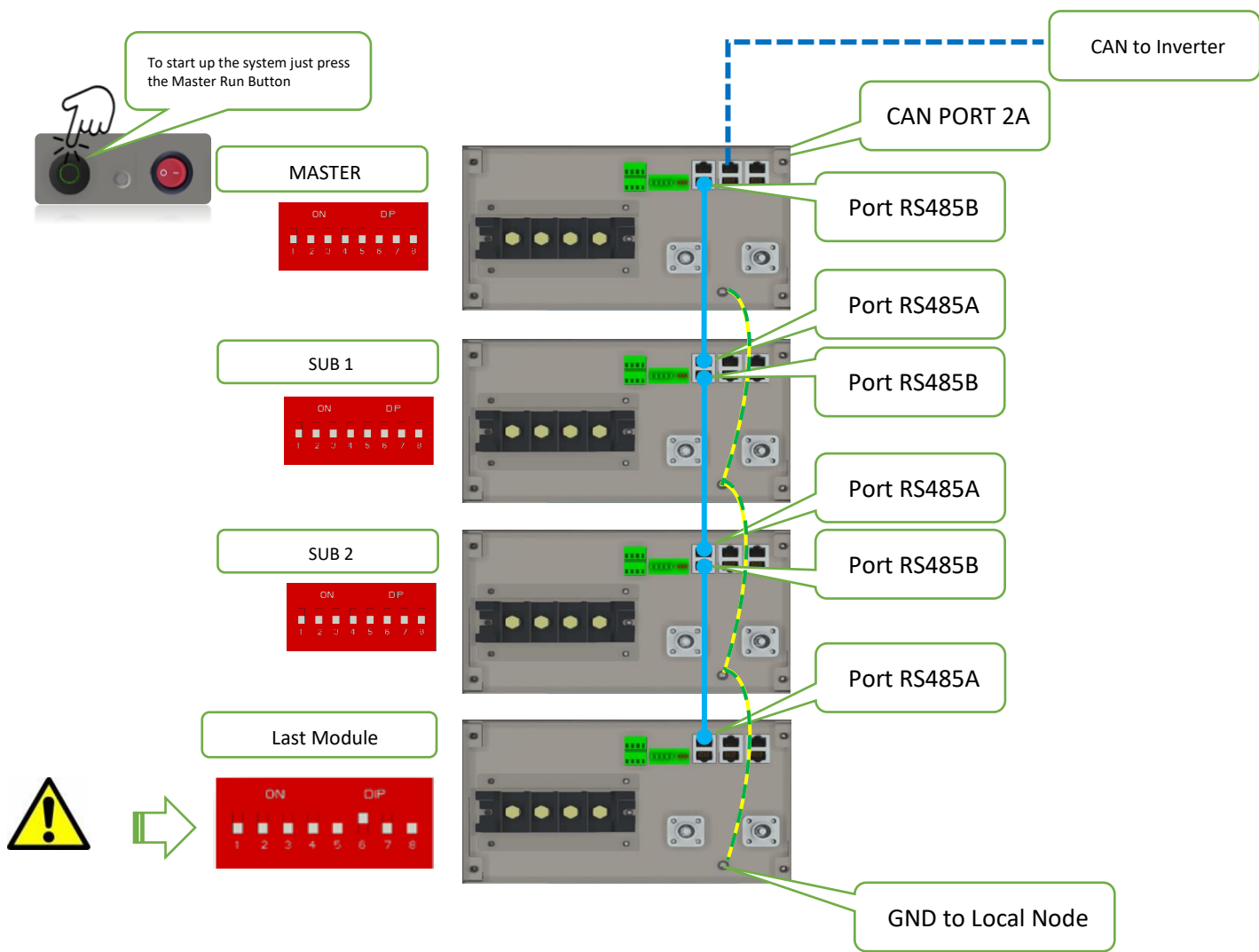

**ATTENZIONE**

Power cables must be connected to the batteries that make up the cluster when the batteries are turned off.

The power cables to the inverter or to the common BAR BUS must be prepared and before the connected cluster is switched on (closed circuit).

LOW VOLTAGE

## 2.5.1 Auto ID Assignment and DIP Configuration for LOW Voltage Single Cluster (Parallel Connection)

### STEP 1

#### ACTIVATING THE BMS FROM THE POWER SWITCH

It will be necessary to activate all the batteries by switching on the POWER SWITCH (ON= position 1)

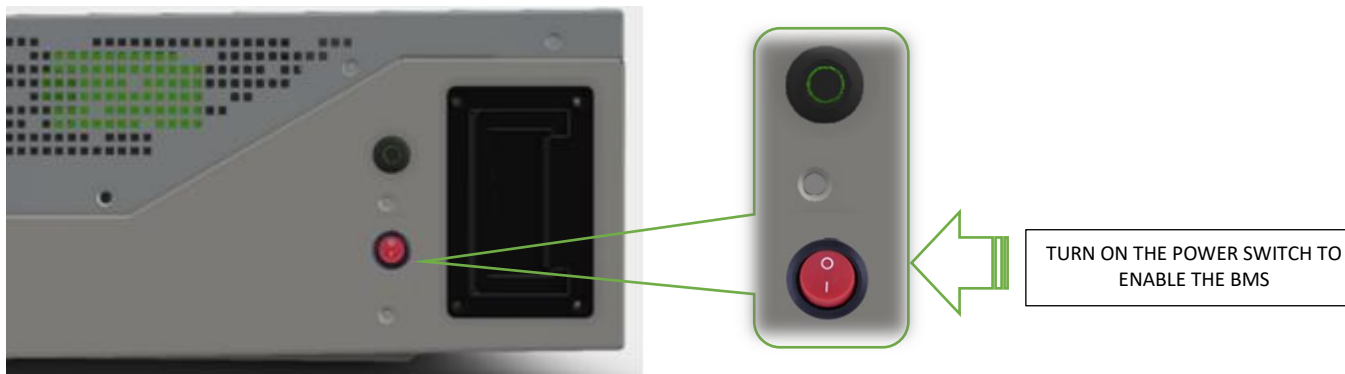

### STEP 2

#### AUTO WAKE-UP PROCESS (Pressing the RUN BUTTON)

Once all the connections have been checked, it is possible to start the Battery Module by enabling the automatic wake-up process.

Press the RUN button of the MASTER battery, the RUN BUTTON will Blink and will wake-up all the slaves batteries connected.

This process might take around 2-3 seconds per battery (Do not turn on the SUB manually as the automatic process will assign a battery ID in sequence).

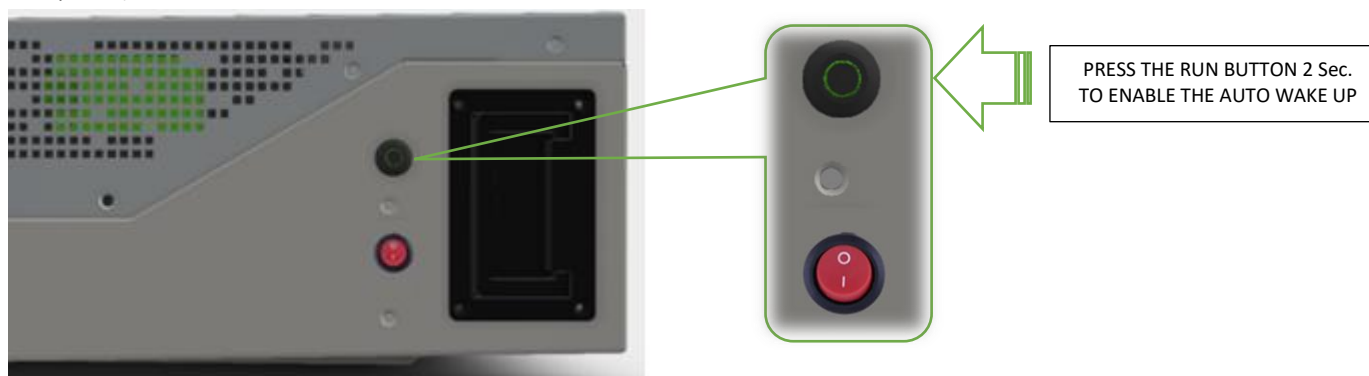

It is essential to check the startup progression and make sure that all LEDs of the RUN BUTTON are ON and showing steady GREEN lights after the wake-up process (the entire process might take up to 30-45 seconds in case of 15 batteries).

During the startup process, all the RUN BUTTONS will blink until the last module sends the final consent to the MASTER to enable the contactors.



If during the process, one or more Battery Modules will not turn ON or if the LED does not become steady, it is mandatory to switch off the MASTER and check all the connections between PORTS RS485 B and A.

Make sure to turn ON and OFF every Battery Module after setting up the DIP switches.

In case of any anomaly during this process, it is necessary to shut down the entire cluster and repeat the procedure from STEP 1.

#### ATTENTION:

All the SUB MODULES will automatically shut down (contactor Open) within 60 seconds from the moment that the master is tuned off, the RUN BUTTON will blink for longer, to shut down manually put the main switch in (0) position.

To completely turn off the cluster, it is compulsory to switch OFF all the POWER SWITCHES of each module.

The RUN Button might blink for several minutes after the circuit opening process (contactor open): this is a normal process necessary to complete any ongoing process between batteries and between master and the cloud service.

To terminate this process without waiting for the normal process it is possible but not recommended to turn off each module by acting on the rocker switch (zero position).

### 2.5.2 Single Cluster DIP and DATA Connection

The DIP SWITCH setting for the SINGLE CLUSTER LV mode has an automatic function that assigns the single module ID in cascade.

It is mandatory to connect each module in Daisy Chain connection starting from the RS485 B PORT of the master unit.

The DIP sequence for the LV single cluster must be



on every module that composes the cluster.

**PRESS RUN BUTTON**  
Only on the 1<sup>st</sup> Module

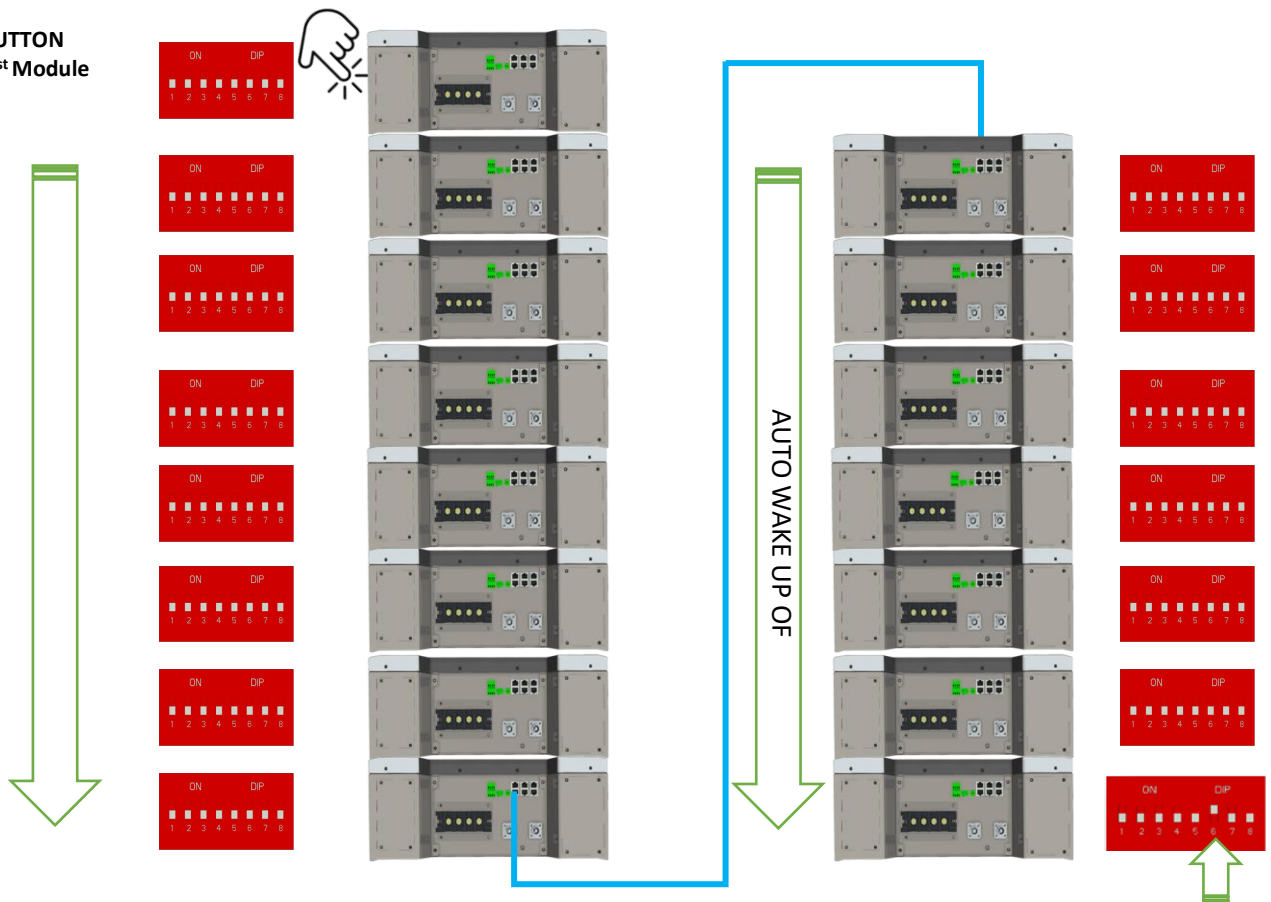

LAST MODULE OF THE LV CLUSTER  
MUST HAVE THE DIP 6 ENABLED



L  
O  
W  
V  
O  
L  
T  
A  
G  
E

### 2.5.3 Parallel Battery Wiring Connections



**ATTENTION:**

POWER CABLE CONNECTIONS MUST BE MADE IN STRICT ACCORDANCE WITH THE INSTRUCTIONS IN THIS MANUAL. INCORRECT POWER CONNECTIONS CAN DAMAGE THE BATTERY MODULE AND CAUSE INJURIES.



# 9,5 Nm / 7 ft lb

**Power Cable Tightness**  
CHECK TORQUE EVERY THREE MONTHS



**Attention:** Screws, Cables and Bus Bar POWER CONNECTIONS on the battery terminal block must be installed with due diligence. Tightening torque refers to the use of a single standard bus bar or cable lug terminal; if using several overlapping or non-standard bus bars/terminals, check screw length  $\geq$  16mm.



**Attention:** All drawings are for reference only. Always refer to the physical product as the standard. If the manual does not match the physical product, stop all actions, remove any connections, store the batteries in a safe place and call your WeCo technical representative for assistance.



**Attention:** For the power cable connection for high current, please refer to the specific section to see the diagram. Charging current limitation is mandatory as per this instruction manual.

TIGHTENING TORQUE TABLE

Screw Diameter (ISO)	Max Fixing Torque	Application	Construction Applied Torque
Code	[Nm]		[Nm]
M3	1.7	BMS protection Cover	1,2
M4	3.8	External Covers	3
M5	7.5	Isolators and Contactor Supports	7
M6	10	Fuses, Cables and Cable Lungs Connection to Terminals /Feet /Brackets/ Wall Plugs	10
M8	14	Plastic to steel and Cables on Terminal Block / Feet / Brackets / Wall plugs	14
M8	32	Steel on Steel Connection / Steel to copper/ Contactor terminal to Bus bar)	16
M10	62	External Bus Bar ( Aluminium and Copper) steel on steel connection	40
M12	107	External connections, copper to copper joints	80



**ATTENTION**

If during the quarterly check the screws will have residual torque lower than these values, it means that the cables and the busbar are subjected to out-of-range currents and the thermal effect is loosening the screws / bolts

### 2.5.4 Low Voltage Single Stack Power and Data Connections (15-Modules Maximum)

Proceed with the physical installation of the desired quantity and configuration of the Battery Modules, following the installation sequences and guidelines as described in Section 1 and Section 2 of this manual.

Connect the power cables as indicated below, making sure that all the batteries are OFF (check the power switch on the side) and always measure the terminals with a multimeter to check for **ZERO VOLTS**.

As per UL regulation, a circuit breaker is compulsory to separate the battery circuit from the inverter.

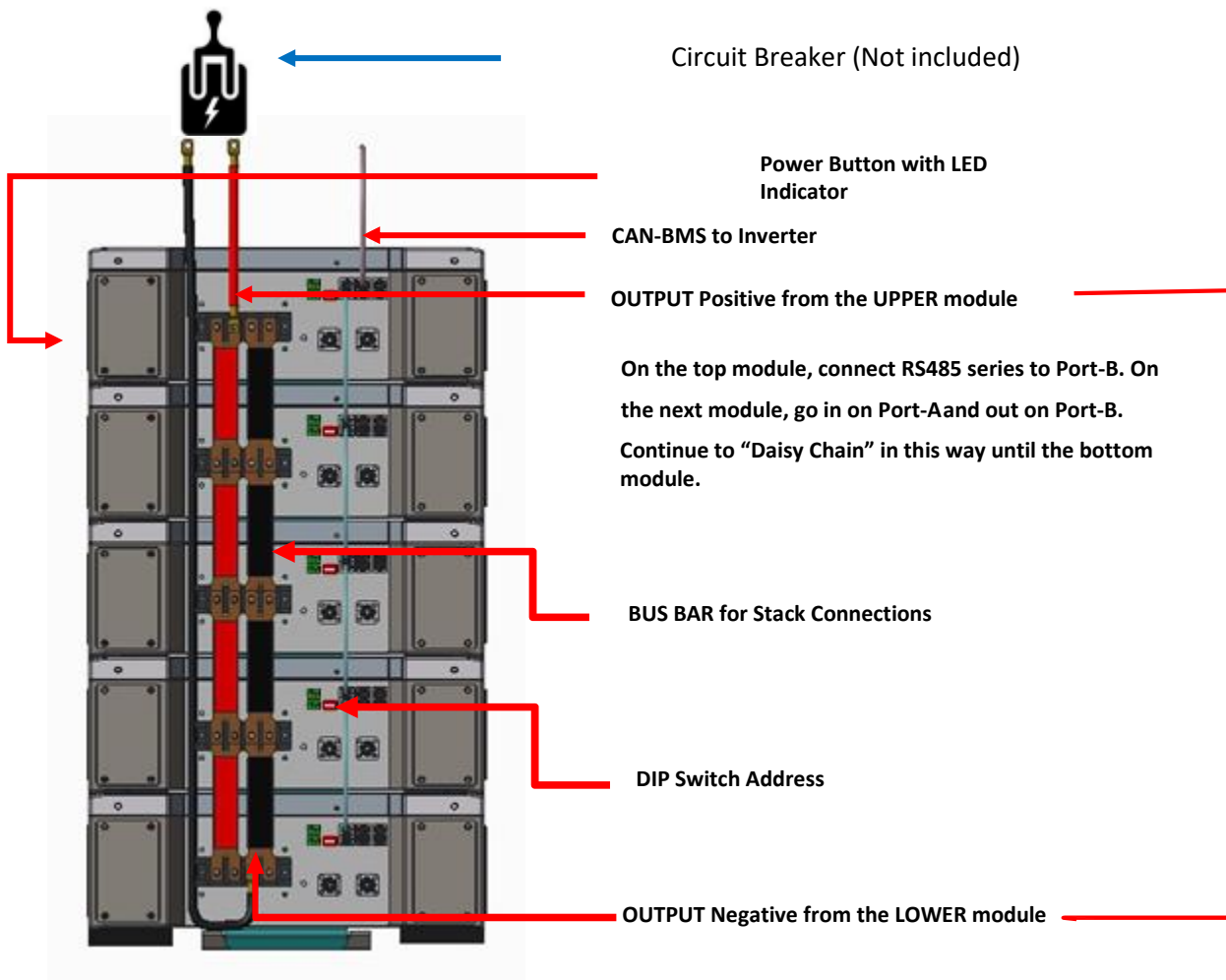

**Information:** When multiple Battery Modules are connected in parallel the master battery will dynamically control the maximum current of the cluster by sending the reduce current value to the inverter.



**Attention:** Be sure to follow the above method of "Daisy Chaining" the RS485 connections, starting at Port-B on the upper Battery Module, then into Port-A on the next module and out of Port-B, then into Port-A on the next module, and so on.



**Caution:** B+ interface is always positive, B- interface is always negative; GND is for the parallel battery grounding Port.



**Caution:** For Pass-through connections with bus bar the max Charge/Discharge current must be limited to 300Adc  
Above 300A it is necessary to connect each module individually to a common bus bar.



**Information:** Connect the cables according to the installation requirements, always paying attention to minimize the length of the cables to avoid voltage drops.



**Attention:** To ensure safety and stability of the cluster always interlock the Battery Modules using the feet.

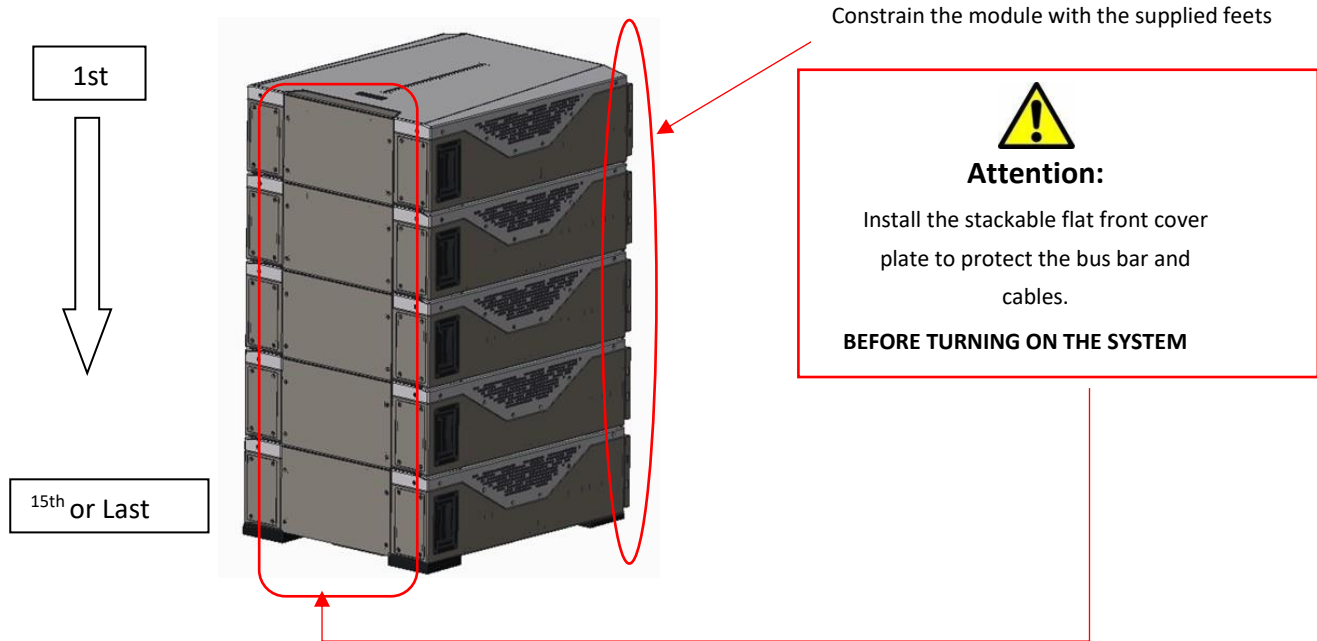

Battery Modules installed correctly, see image below.

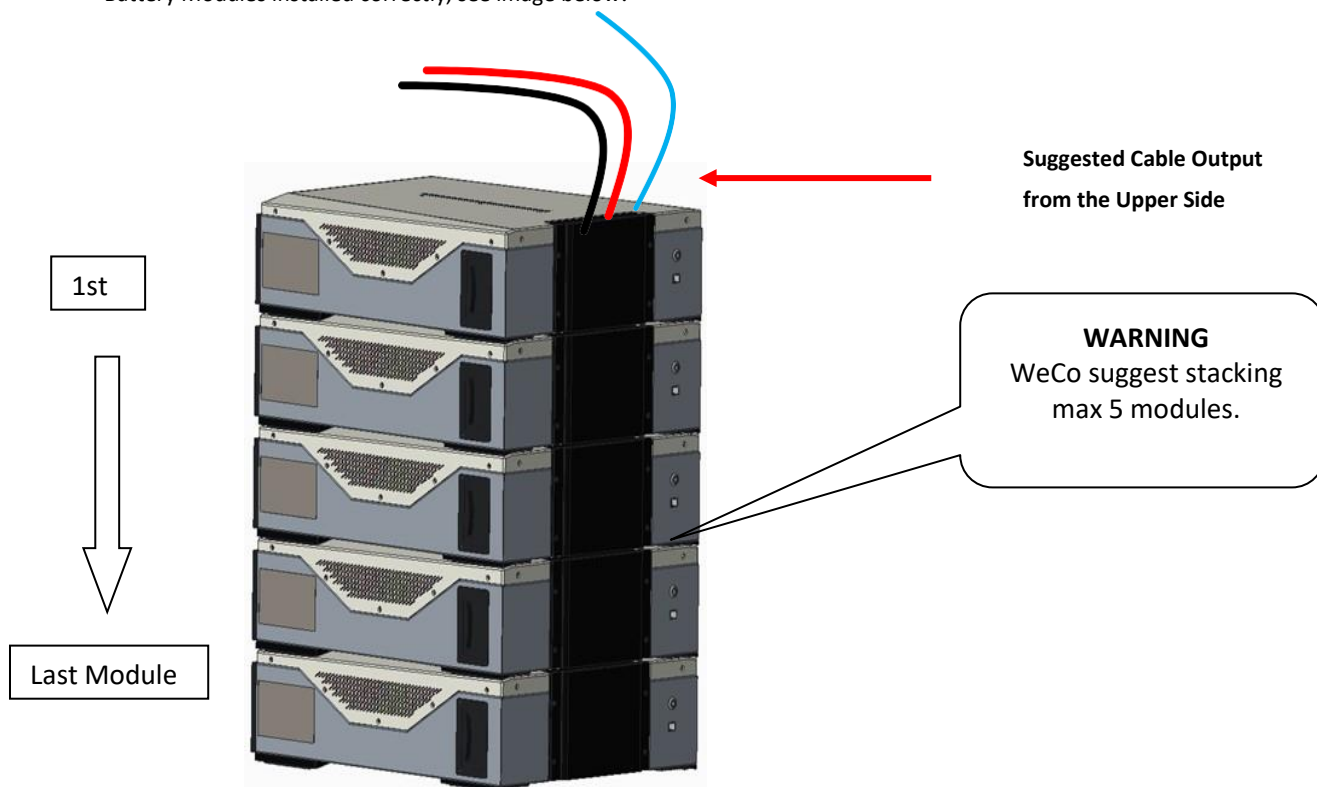

**Attention:** Illustrations shown are for reference only. Please always refer to the physical Battery Module in front of you: if the module has a different configuration to this manual, stop all activity immediately and contact your WeCo technical service representative.

### 2.5.5 LED Bar Indications

#### LED Bar is located just above the RUN BUTTON and the BMS SWITCH

Start Up: LED1-LED5: Green 5 seconds.

Running: il LED1-LED5 become blue and the SOC level is displayed.

**SOC STATUS**



- SOC 90-100%
- SOC 55-89%
- SOC 32-54%
- SOC 6-31%
- SOC 5% \* (Yellow when SOC is below 4,9%)

If the WiFi is Enabled / Paired the first LED will become Green

**FW UPGRADE**



**ERRORS**

Low voltage contactor open	High voltage contactor open	Low temperature contactor open	High temperature contactor open	High current contactor open	Slave lost communication with Master	BMS Fault
LED1 on RED	LED5 on RED	LED2 on RED	LED4 on RED	LED3 on RED	LED1-LED2 on RED	LED1-LED5 on RED

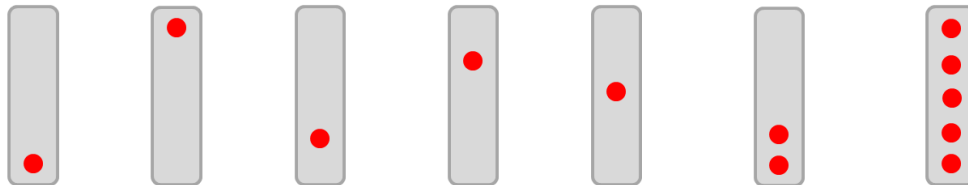

During the running time, the LED bar shows the SOC value all the time (In HV the LED bar show the Battery ID, while the LED bar of the HV Box will show the SOC value).

If any error occurred, the above red LED sequence will appear every 5 seconds alternating the SOC value with the error code.

**After each important event that causes the BMS safety intervention, the BMS logic allows four reconnections attempts, the first, after 4 minutes.**

**If the same condition recurs, the next three attempts will be every 4 hours for a maximum of 48 hours.**

## 2.6 Stand Alone Battery Front Panel Control

### 2.6.1 Start Battery

Press the Run Button for 2-seconds. The GREEN RUN light should come on. The Battery Module has been activated normally.

### 2.6.2 Shut Down Battery

Press and hold the RUN Button for 5-seconds. The GREEN RUN light should go off. The Battery Module has been shut down normally.

### 2.6.3 Low Battery – Force Charge

**Prerequisite:** The **VOLTAGE** between the battery B + and B- terminals is **ZERO** and the **PANEL LIGHTS ARE OFF**. Battery is in “Shutdown State.”

**Preparation condition before forced charging:** Connect the charger or the inverter with charging capability to the B+ and B- of the Battery Module to ensure charging capacity.

**Forced charging approach:** By shortly pressings the Battery Module Run Button, the battery RUN light will flash GREEN which means that the battery is entering the compulsory charging mode. If the battery receives adequate charging power (above 10 Amps/Max 58Vdc) within 90 seconds from pressing the button, the battery will continue to charge normally until a stable state is reached.

If the battery does not receive adequate charging power within 90 seconds after pressing the button, the battery will enter the shutdown mode once again.

During the forced charging period, the FRONT LED BAR low battery LED will be steady orange up to a SoC of 10% at which point the low battery LED will go out.

## 2.7 Parallel Battery Configuration

1. The voltage difference between any of the Battery Modules in the stack must not be greater than 2V, otherwise the BMS will not allow the batteries to be activated in a parallel connection.
2. SoC of each battery in the stack must be the same (Check the SoC of each individual battery module before connecting in parallel).
3. The power cabling between the Battery Modules must be in accordance with section 5.6 of this manual.
4. All DIP switches are configured in accordance with this manual.
5. The RS485 inter battery data connections must be properly connected as per section 5.6 of this manual. The data connection “Daisy Chain” must start from PORT-B of the master battery (do no install the RS485 on the PORT-A of the master battery as it will result in a fault).
6. Connect the CAN PORT of the master Battery Module with the CAN PORT of the inverter and make sure that the communication is working properly by checking the inverter display.
7. Before activating the system, the operator should check the cable connections carefully and make sure that all safety procedures are respected. Check the inverter settings and connection before turning on. In case of an inverter without communication, make sure to set the voltage and current value as per the charge/discharge parameters provided in this manual.

### 2.7.1 Activation of Parallel Batteries (From Master to last module for a maximum of 15)

Turn ON the Power Switch on all battery modules to be connected in parallel.

Press the Master RUN Button for 2-seconds. The GREEN RUN light should come on. The battery has been activated normally.

Each sub module will start up automatically.

### 2.7.2 Shutdown of Parallel Batteries

Press and hold the Master Run Button for 5-seconds. The GREEN RUN light should go off immediately. The GREEN RUN lights on the sub batteries will not be extinguished immediately.

The RED FAULT lights on the sub batteries' FRONT LED bars will start flashing after ten seconds and the GREEN RUN lights will remain on.

After one minute the RED Fault lights on the FRONT LED bars and the GREEN RUN Button lights on all sub batteries will go off.

Turn OFF the POWER SWITCH of each battery.

The parallel battery system has shutdown properly.

The RUN button might flash for several minutes, this process is normal when there is an upgrade ongoing or when there is a new FW detected.

Even if the contactor is OPEN, (OPEN CIRCUIT) the BMS can still operate in background, please let the process complete and wait for the RUN BUTTON to stop flashing waiting for the automatic shutdown.

A forced shut down is possible by putting the main switch in (0) position, this might cause the interruption of FW upgrade pushed from the APP or from the Local software XP MANAGER.



#### NOTICE:

When a Master battery is offline in a fault state or has been manually shutdown, the entire cluster will go offline until the Master comes back online.

To restart the Cluster, it is mandatory to repeat the Cluster Start Up procedure. First make sure to shut down all batteries by setting the power switch to the off (0) position, then set all power switches to the ON (1) position and press the master RUN BUTTON to enable the startup process again.



#### NOTICE:

In a parallel battery system, we strongly advise not to switch off individual sub batteries when the system is running, either in Charge or Discharge Mode as this process might affect the communication between modules and inverter.

Switching off an individual sub battery in a parallel system is possible in an adverse situation, but only as a last resort and prior switching off the solar inverter.

### 2.7.3 LV Direct Parallel Connection WITH Certified Inverter BMS Communication (Closed-Loop)

Note that for installations WITH certified Inverter BMS Communications the maximum number of battery modules per installation is limited to seven clusters of fifteen batteries per cluster. The 5K3-XP Low Voltage Hub must be used when the installation has more than one cluster.

5K3-XP	Data / Functions	
Nominal voltage	51.2	
Capacity Ah	105	
Nominal Capacity	5.37 kWh	
Standard Charge /Discharge current	50A	
BMS Maximum charge/discharge current	100 /100Adc	
Discharge peak (admitted by bms)	200 Adc Peak 5 sec	
Extreme voltage range BMS safety min max values for Voltage	45.5 Vdc	58.4 Vdc
Depth of discharge (max)	Up to 100%	
Depth of discharge	Up to 90%	
Emergency conservative charge @ 0.05C	-5 °C to -2°C	
Charging temperature @ Max 0.05C	-2°C to 5°C	
Charging Temperature @ Max 0.1C	6°C to +9°C	
Charging Temperature @ Max 0,3C	10°C to +14°C	
Charging Temperature @ Max 1C	+15°C to +45°C	
Charging Temperature @ Max 0,3C	+46°C to +50°C	
Charging Temperature @ Max 0,1C	+51°C to +54°C	
Discharge temperature @ Max 0.5C	+55°C to +45°C	
Discharge temperature @ Max 1C	+45°C to 10°C	
Discharge temperature @ Range 0.1C to 0.5C	0°C to -7°C	
Discharge temperature @ Max 0.1C	-7°C to -20°C	
Self-Discharge Rate	1% self-discharge per month @ 77°F / 25°C	

L  
O  
W  
V  
O  
L  
T  
A  
G  
E

## 2.8 Power Connection of a Single Cluster

### -BUS BAR max 300A dc Peak-



**ATTENTION:** Both ends of the cluster must be connected with two output 50 mm<sup>2</sup> or 75mm<sup>2</sup> cables.

Cables length shall not exceed 250cm.

The suggested output cable is composed of two sets of 50 mm<sup>2</sup> each of max length of 200cm.

**ATTENTION:** The terminal block pole can support a 19mm width Cable Lug.

2X 50 mm<sup>2</sup> = 2 cables 50 mm<sup>2</sup> connected to both poles.

(Positive pole has two connection screws, Negative pole has two connection screws).

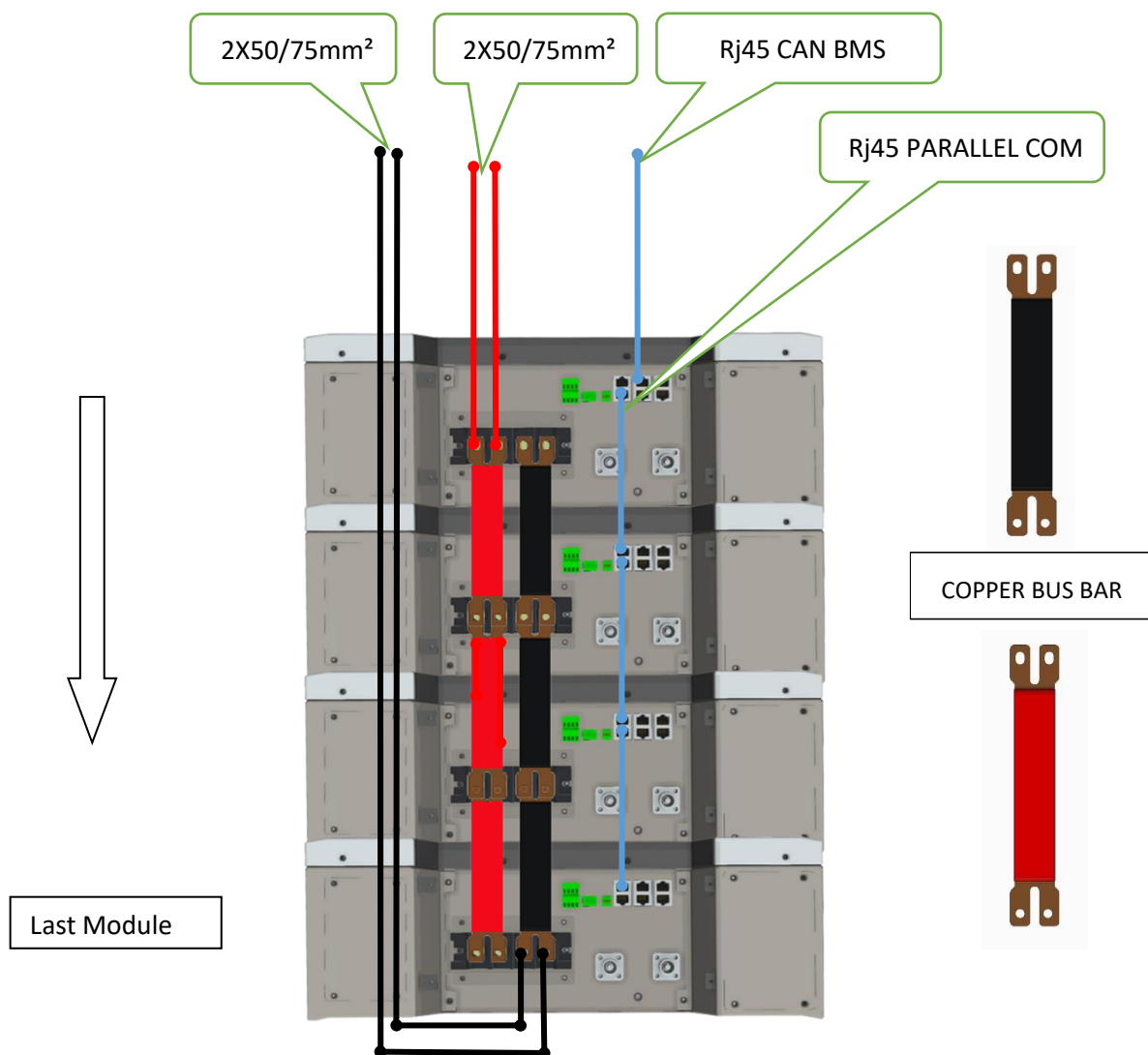

### INFORMATION



9,5 Nm / 7 ft lb

Terminal Block must be checked every 3 months.

Cable size verification for a cluster composed by 5 or more Battery Modules connected to the inverter with 2 sets of cables (50mm<sup>2</sup> each) for a total of 100 mm<sup>2</sup> each terminal (positive and negative).

When more than one battery is connected in parallel, we suggest using a capacity reduction factor of 2% to calculate the Cluster Capacity at the first installation.

When used in Cluster the Initial Capacity is calculated in 5.2kWh per Module.

Numbers of Modules	C-Rate	Current Allowance	Power W
1	1	100	5.200
2	0.98	196	10.192
3	0.96	288	14.976
4	0.94	376	19.552
5	0.92	460	23.920
6	0.9	540	28.080
7	0.88	616	32.032
8	0.86	688	35.776
9	0.84	756	39.312
10	0.82	820	42.640
11	0.8	880	45.760
12	0.78	936	48.672
13	0.76	988	51.376
14	0.74	1036	53.872
15	0.72	1080	56.160



### ATTENTION

The Battery Terminal Block can support max 50/75mm<sup>2</sup> on each connection point (two each pole).  
It is mandatory to set the maximum inverter current in accordance with the output cables capabilities.



### ATTENTION

Cable sizing must be calculated by a qualified technician/engineer, based on local regulations, and in accordance with overall system design.

## 2.9 CAN HUB XP MODEL

**Required for installations of more than 1 cluster.**

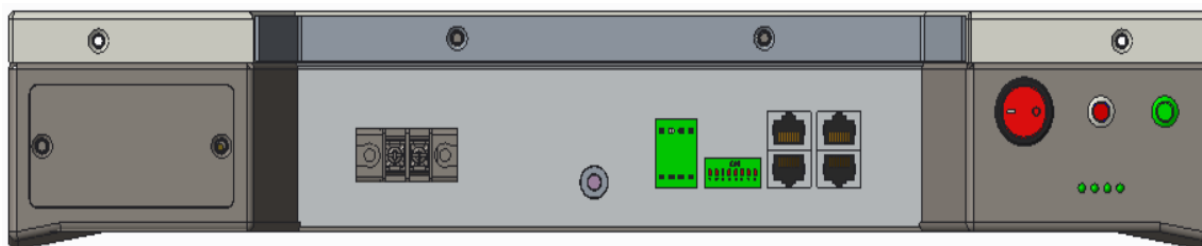

### 5K3-XP LOW VOLTAGE HUB-XP



The use of this device is mandatory when multiple clusters are connected to a common bar bus.



Each battery pack and cluster must have the same voltage and firmware.  
All stack configurations must use the WeCo Bus Bar up to max 300Adc.  
Each cluster must have the same number of battery packs with the same firmware.



**The HUB works only with WECO approved inverters and only via CAN BMS.**



**For more detailed information on the use and connections of the HUB consult the specific manual.**

## 2.10 Low Voltage Inverter Compatibility List

INVERTER BRAND		MODEL	Battery Protocol Selection	Modules	Modules in Parallel with WeHub
	ZCS Azzurro	SP3000/HYD	WeCo CAN	15	105
	Deye	All	CAN00	15	105
	Play LV	52V	WECO CAN	15	105
	MLT Inverters	Hybrid CAN comm	CAN00	15	105
	Schneider	XW	CONEXT CAN	15	105
	Solis	LV All	SOLIS CAN	15	105
	Growatt	SPH LV	GROATT CAN	15	105
	SMA	Sunny Island	SMA CAN	15	105
	Goodwe	S-All LV Hybrid	GOODWE CAN	15	105
	Studer Innotec	Xtender	STUDER CAN	15	105
	Sofar Solar	All	WeCO CAN	15	105
	Victron Energy	Via Colour Control	VICTRON CAN	15	105
	TBB	ALL	CAN00	15	105
	INVT-MEGA	LV All	INVT CAN	15	105
	Imeon Energy	All	IMEON CAN	15	105
	Voltronic Power	LV All	VOLTRONIC CAN	15	105
	Morningstar	Open Loop	OPEN LOOP	15	/
	Kehua Tech	Hybrid LV All	CAN 00	15	105
	Must Solar	PH / PV	OLP CAN	15	105
	Lux Power Tek	LV Hybrid All	WECO CAN	15	105
	Solax Power	SKU-LV All	SOLAX CAN	15	105
	Sungrow	SH3K6/SH4K6	WECO CAN	15	105
	Steca	Open Loop	OPEN LOOP	5	/
	OutBack	Open Loop	OPEN LOOP	5	/
	(No BMS/Alpha CAN)				
	TSUN	LV Hybrid All	WECO CAN	15	25
	MPP	LV ALL	OLP CAN	15	25
	Autarco	LV ALL	SOLIS CAN	15	105

## 2.11 Low Voltage Inverter Battery to Inverter CAN Terminal Pin Out

LOW VOLTAGE INVERTER CAN / BMS				
T568B 	CAN TERMINAL	Inverter Terminal Type	Inverter SIDE ( PIN Number )	Battery SIDE RJ45 (PIN Number)
SMA SUNNY ISLAND	CAN L	RJ45	5	2
	CAN H		4	1
	GND			3
ZCS HYD / SP	CAN L	RJ9	2	2
	CAN H		1	1
	GND		3	3
KEHUA SPH	CAN L	RJ45	2	2
	CAN H		1	1
	GND			3
GROWATT	CAN L	RJ45	5	2
	CAN H		4	1
	GND		X	3
DEYE	CAN L	RJ45	5	2
	CAN H		4	1
	GND		2	3
VOLTRONIC	CAN L	RJ45	7	2
	CAN H		6	1
	GND			3
PHOCOS	CAN L	RJ45	7	2
	CAN H		6	1
	GND			3
TBB	CAN L	RJ45	5	2
	CAN H		4	1
	GND		2	3
VICTRON	CAN L	RJ45	8	2
	CAN H		7	1
	GND		3	3
SOLIS	CAN L	RJ45	5	2
	CAN H		4	1
	GND		2	3
SCHNEIDER	CAN L	GATEWAY	5	2
	CAN H		4	1
	GND			3
INGETEA M PLAY 48/400V Single Phase	CAN L	SCREW TERMINAL	CAN H	2
	CAN H		CAN L	1
	GND			3

### INFORMATION

All CAN and RS485 communication cables are of the T568 type. B  
 The CAN/BMS communication cable between battery and inverter varies depending on the inverter model.  
 Battery side must be kept in the original configuration while inverter side must be modified according to the instructions of the inverter manufacturer.

## SECTION 3 - HIGH VOLTAGE CONFIGURATION

### SERIAL CONNECTION AND SYSTEM CONFIGURATION

#### HIGH VOLTAGE STACKABLE CONFIGURATION



**ATTENTION:**

**THIS SECTION IS FOR HIGH VOLTAGE CONFIGURATION ONLY**

**IT IS COMPULSORY TO USE THE 5K3-XP HV BOX  
FOR THIS CONFIGURATION**

**HV BOX XP is not compatible with LV/HV batteries.**

### 3.1 Product Introduction

The WeCo 5K3-XP Battery Modules can be used as an on-grid or off-grid energy storage system. It is not recommended to use this product for any purpose other than the intended purpose as described in this document.

Use of this product other than as described in this document will nullify the Product Warranty. The substitution of any components of this battery will nullify the Product Warranty.

The use of any components contained within or connected to this battery other than the products sold as part of this product or recommended by the manufacturer will nullify the Product Warranty.

 **ATTENTION:** Do not exceed the number of 8 modules in each tower.

 **ATTENTION:** The maximum number of Battery Modules that can be connected in series is 16.

 **ATTENTION:** The 5K3-XP HV Box is a compulsory protection and communication device that must be installed for any High Voltage Configuration.

 **ATTENTION:** Attempting to operate a system of Battery Modules with less than four modules in series or more than 16 modules in series will nullify the Product Warranty.

Battery Module Weight 119 lb /54 kg

 **ATTENTION:**

**EXAMPLE:**

**A cluster of 12 Battery Modules weigh 1428.6 lb /648 kg**

**The support structure/floor must be properly inspected by a civil engineer before starting the installation of the modules.**



#### 3.1.1 Identifying the Individual Battery Module

Dimensions	mm	580x474x170
Weight	lb (kg)	119 lb (54 kg)
Case Material	Type	Steel
Modules in series	Max No.	16
Stackable	Type	Yes
Digital Output	No.	2+2
Cell Distribution	P/S	16S

Cell type	mm	LiFePO4
BMS Extreme Charge Temp	°F (°C)	+19.4°F to +131°F* (-10°C to +55°C*)
BMS Discharge Temp	°F (°C)	+131°F to -4°F* (+55°C to -20°C*)
Recommended Storage and usage Temp	°F (°C)	+77°F (+25°C)
Storage Temp/Time outside the suggested storage temperature	°F (°C)	-13°F to +131°F / 3 months (-25°C to +55°C / 3 months)
Self-Discharge @ STC 77°F (25°C)	%	1% per month
Self-Discharge outside the STC	%	> 3% per month

### 3.1.2 Product Identification and labels

The nameplate label describes the product parameters and is attached to the product. For details, please refer to the nameplate label of the product. For safety reasons, the installer must have a thorough understanding of the contents of this manual before installing the product.



## HV BOX XP LABEL (Example)

<b>Energy Storage Systems</b> WeCo Srl Viale Kennedy 113-121 Scarperia e San Piero CAP 50038 (FI)		<b>HV BOX XP</b> <b>750V</b>
Emergency Number ITALY + 39 055-0357960	www.wecobatteries.com service@wecobatteries.com	
Prodotto/ roduct	HV BOX XP (MY 2023)	
Modello/Model	5K3 XP MY2023	
Intervallo di Tensione Operativa/Operating Voltage Range	80-750Vdc	
Numero Ingressi/Number of inputs	1+1	
Corrente Massima per ingresso/ Max Current per Input	100A ( 50A per canale/50A per input)	
Corrente Max Carica Scarica/Max Charge Discharge Current	100A	
Protezioni di Sicurezza Attiva/Active Safety Protection	150A Contattore Automatico/Automantic Contactor	
Protezioni di Sicurezza Passiva/Passive Safety Protection	Fusibile / Fuse 200A-750Vdc	
Sezionatore Generale Manuale/Manual Main Breaker	125A/1000Vdc	
Intervallo Max di Temperatura/Max Temperature Range	0-45°C	
Temperatura di stoccaggio/Storage Temperature	from -10°C to +55°C	
Max N° batterie connesse/Max N° Batteries connected	12 Batterie in Serie/12 Batteries in Series - Max 750Vdc	
Peso/Weight	18Kg	
Dimensioni/Dimensions	580x470x170mm	
Grado di Protezione IP/IP Grade	IP20 (Solo per Uso Interno/Indoor Use only)	
Standards	EMC(EN61000-6-3:2007/A1:2011/AC:2012) EN IEC 61000-3-2:2014 EN IEC 61000-3-3:2013 EN IEC 61000-3-1:2007 CE	
Numero Seriale/Serial Number Questo prodotto deve essere installato e mantenuto solo da operatori professionali qualificati. Leggere attentamente il M manuale di Uso M manutenzione prima di operare. Il mancato rispetto delle prescrizioni contenute nel manuale fa decadere la garanzia. This product must be installed and maintained by qualified professional installers. Read carefully User Manual before use. Inproper use and installation will void the warranty. Este producto solo debe ser instalado y mantenido por operadores profesionales calificados. Lea atentamente el Manual de Uso y Mantenimiento antes de operar. El incumplimiento de las instrucciones contenidas en el manual invalidará la garantía.		
RISPETTARE LA POLARITA' DELL'HV BOX DALLA STRINGA DI BATTERIE RESPECT THE POLARITY OF THE HV BOX FROM BATTERY STRING		

<b>Energy Storage Systems</b> WeCo Srl Viale Kennedy 113-121 Scarperia e San Piero CAP 50038 (FI)		<b>HV BOX XP</b> <b>1000V</b>
Emergency Number ITALY + 39 055-0357960	www.wecobatteries.com service@wecobatteries.com	
Prodotto/ roduct	HV BOX XP (MY 2023)	
Modello/Model	5K3 XP MY2023	
Intervallo di Tensione Operativa/Operating Voltage Range	150-1000Vdc	
Numero Ingressi/Number of inputs	1+1	
Corrente Massima per ingresso/ Max Current per Input	100A ( 50A per canale/50A per input)	
Corrente Max Carica Scarica/Max Charge Discharge Current	100A	
Protezioni di Sicurezza Attiva/Active Safety Protection	150A Contattore Automatico/Automantic Contactor	
Protezioni di Sicurezza Passiva/Passive Safety Protection	Fusibile / Fuse 200A-750Vdc	
Sezionatore Generale Manuale/Manual Main Breaker	125A/1000Vdc	
Intervallo Max di Temperatura/Max Temperature Range	0-45°C	
Temperatura di stoccaggio/Storage Temperature	from -10°C to +55°C	
Max N° batterie connesse/Max N° Batteries connected	16 Batterie in Serie/16 Batteries in Series - Max 1000Vdc	
Peso/Weight	18Kg	
Dimensioni/Dimensions	580x470x170mm	
Grado di Protezione IP/IP Grade	IP20 (Solo per Uso Interno/Indoor Use only)	
Standards	EMC(EN61000-6-3:2007/A1:2011/AC:2012) EN IEC 61000-3-2:2014 EN IEC 61000-3-3:2013 EN IEC 61000-3-1:2007 CE	
Numero Seriale/Serial Number Questo prodotto deve essere installato e mantenuto solo da operatori professionali qualificati. Leggere attentamente il M manuale di Uso M manutenzione prima di operare. Il mancato rispetto delle prescrizioni contenute nel manuale fa decadere la garanzia. This product must be installed and maintained by qualified professional installers. Read carefully User Manual before use. Inproper use and installation will void the warranty. Este producto solo debe ser instalado y mantenido por operadores profesionales calificados. Lea atentamente el Manual de Uso y Mantenimiento antes de operar. El incumplimiento de las instrucciones contenidas en el manual invalidará la garantía.		
RISPETTARE LA POLARITA' DELL'HV BOX DALLA STRINGA DI BATTERIE RESPECT THE POLARITY OF THE HV BOX FROM BATTERY STRING		

Label and tech data may vary

3.1.3 HV BOX XP Dimensions

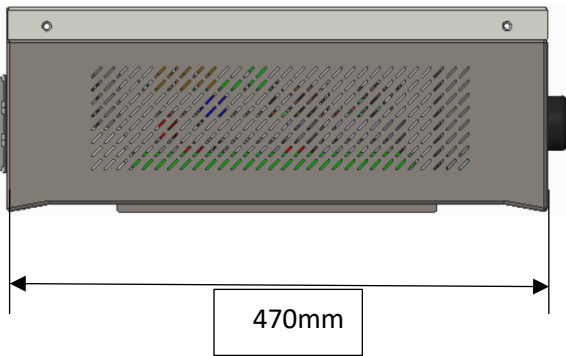

**HV BOX XP TYPE A/B Specs**

Description	Um	Type A	TYPE B
Dimensions	mm	580 x 470 x 170	
Weight	lb (kg)	39.7 lb (18 kg)	
Case Material	Type	Steel	
Operative Voltage (Type B)	Vdc	80-750	150-1000
IP	-	20	

H  
I  
G  
H  
  
V  
O  
L  
T  
A  
G  
E

### 3.1.4 Battery Module Accessory List (HV Standard Kit)

*Kit Composition may be different in certain Countries, always confirm the accessories before placing the order.*

The Battery Module is packed in a carton together with standard accessories. When unpacking, be sure to check that the Battery Module and accessories are free from damage and that the correct quantities of each component are included within the carton.





According with contractual agreements the battery can be shipped only with the HV KIT which includes only the HV POWER CABLE and the CAN RJ45 cable.

The following list of components can be used as a checklist when unpacking the individual Battery Module and accessories when ordered.













**ATTENTION**

The LV KIT cables cannot be used to connect the batteries in High Voltage as the cables are not designed for HV.









Cable Color	Cable Size	Cable Length	QTY	Description	Image
RED	25mm <sup>2</sup>	15cm	N° 1	String double side fast connector, one side Black – one side Red <b>For HV serial connection only</b>	
BLUE	CAT 5	25cm	N° 1	RJ 45-RJ 45 CAN HV communication cable <b>For HV battery data communication link</b>	
RUBBER FEET 100X90X3mm			N° 4	Rubber tape pads for single module insulation	
HANDLES			N° 2	Handles for lifting the module	

3.1.5 HV BOX KIT (Included in the HV BOX carton Box)

Cable Color	Cable Size	Cable Length	QTY	Description	Image
RED	25mm <sup>2</sup>	15cm	N° 1	1 <sup>st</sup> Module to HV BOX double side fast connector, both side Red	
BLAC	25mm <sup>2</sup>	250cm	N° 1	Last Module to HV BOX double side fast connector, both side Black	
RED	25mm <sup>2</sup>	250cm	N° 1	Serial connection between towers, double side fast connector, one side black – one side red	
RED	10mm <sup>2</sup>	500cm	N° 2	Power charging cable from Inverter to HV BOX, one side fast connector red – one side STAUBLI blue	
BLACK	10mm <sup>2</sup>	500cm	N° 2	Power charging cable from Inverter to HV BOX, one side fast connector black – one side STAUBLI blue	
BLUE	CAT 5	250cm	N° 1	RJ 45-RJ 45 CAN HV communication cable for towers connection	
GREY	CAT 5	500cm	N° 1	RJ45 2 PIN CAN HV communication cable from HV BOX to Inverter	
GREY	CAT 5	250cm	N° 1	RJ 45-RJ 45 CAN HV communication cable for HV BOX parallel connection	
HOLDING BRACKET HV BOX			N° 8	Bracket for HV BOX stack secure mounting + Screws	
RUBBER FEET 100X50X30mm			N° 8	Rubber insulated supports for tower 1 and tower 2	
RUBBER FEET 100X90X3mm			N° 4	Rubber tape pads for single module insulation	

H  
I  
G  
H  
  
V  
O  
L  
T  
A  
G  
E

**3.1.6 Necessary Installation Tools**

 <p>Multimeter + Current clamp</p>	 <p>Insulated Screwdriver Set</p>	 <p>Insulated Allen Key Set</p>	 <p>Drill + Hammer</p>
 <p>Electrician Scissors</p>	 <p>Insulated Torque Wrench Set</p>	 <p>Lifting Strap + Mechanical Lifter</p>	 <p>RS 232/USB + Screw Terminal (insulated)</p>

**3.1.7 Personal Protective Equipment + 1000 Vdc Insulated Tool Kit**



## 3.2 High Voltage Battery Module Wiring and Set Up

### 3.2.1 Battery Connections

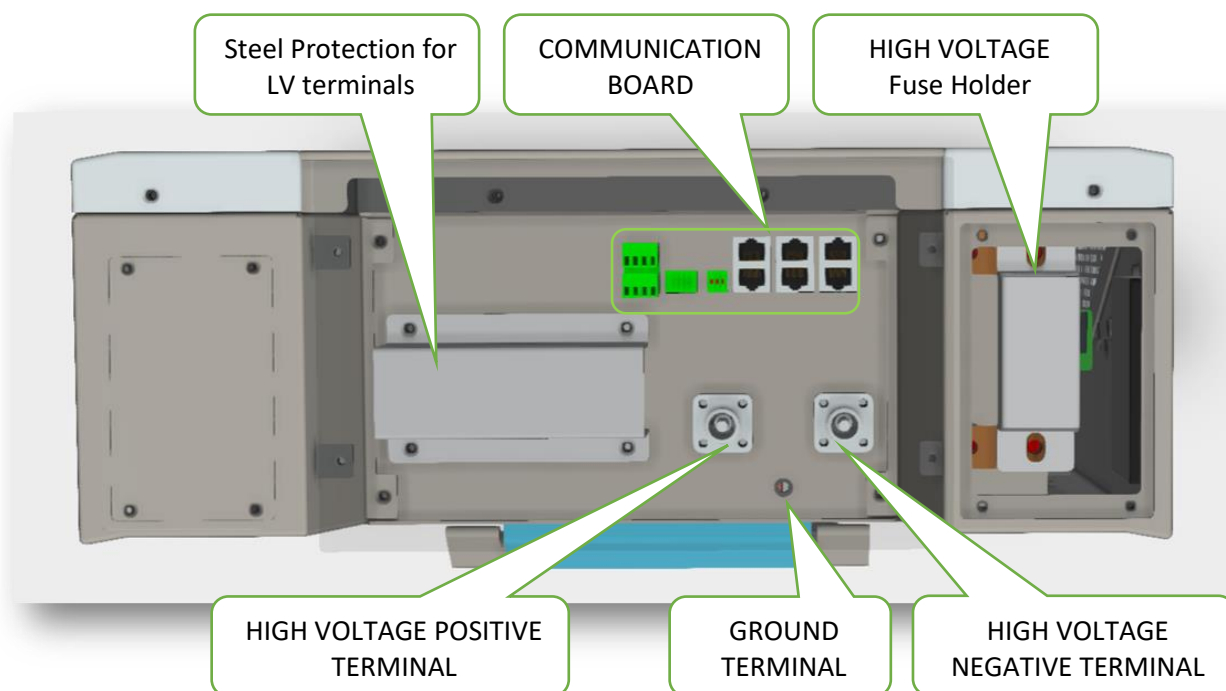

### Module Communication Board

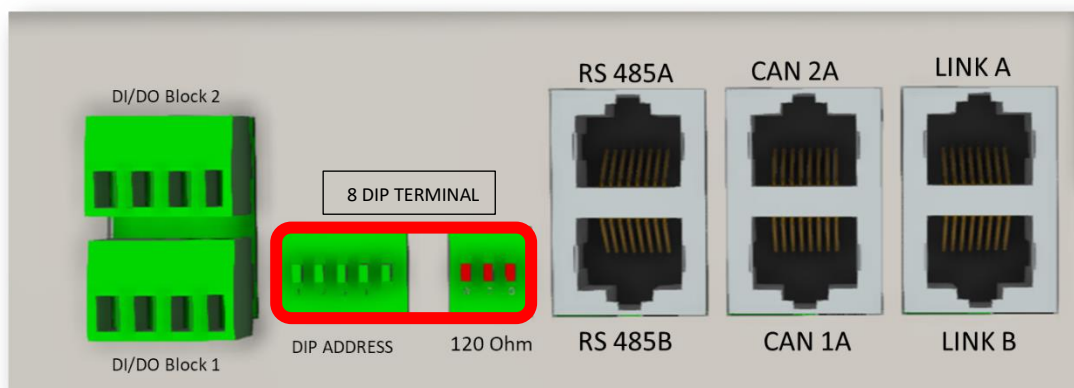

**CAUTION:** The LV fuse is contained in the left portion of the module, the HV fuse is contained in the right portion as shown above.

The access to the fuse is restricted to authorized WeCo service personnel, and the protection lid cannot be opened by anyone else.

### Battery Terminal Definition table

The terminal layout is shown in the following figure:

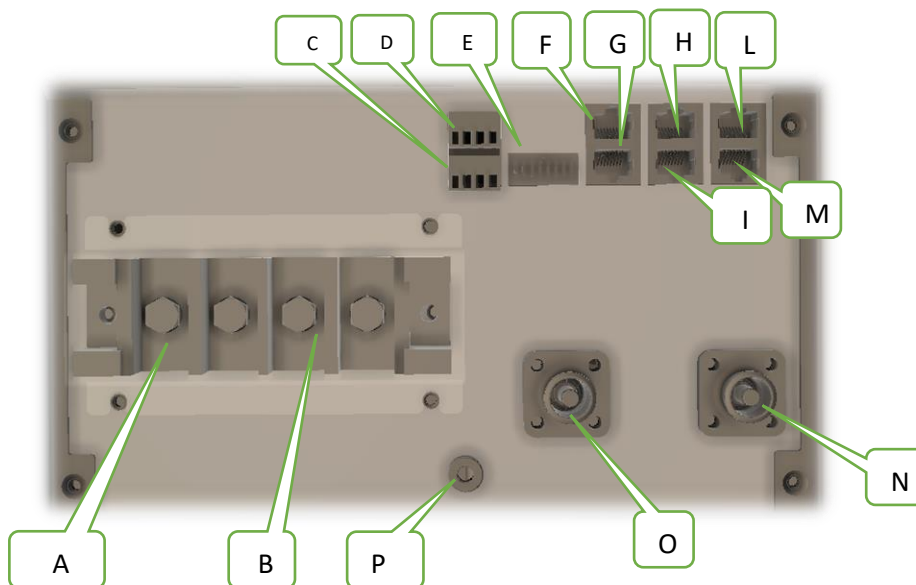

Module Definition Table		
Interface	Name	Function
A	LV POLE +	LOW VOLTAGE POSITIVE (+) Screw Terminal <b>(NO USE IN HV CONFIGURATION)</b>
B	LV POLE -	LOW VOLTAGE NEGATIVE (-) Screw Terminal <b>(NO USE IN HV CONFIGURATION)</b>
C	D/I	DIGITAL INPUT
D	D/O	DIGITAL OUTPUT
E	DIP SWITCH	8 PINS DIP SWITCH
F	RS485A	RS 485 PORT A FOR PARALLEL CONNECTION
G	RS485	RS 485 PORT B FOR PARALLEL CONNECTION
H	CAN LINE	CAN A FOR SERIAL CONNECTION
I	CAN LINE	CAN B FOR SERIAL CONNECTION
L	LINK	OPERATOR PORT FOR RS232 – USB ADAPTER
M	LINK	LINK PORT FOR LVHV COMPATIBILITY
N	HV POLE -	HIGH VOLTAGE NEGATIVE (-) Fast Connector Terminal for serial connection
O	HV POLE +	HIGH VOLTAGE POSITIVE (+) Fast Connector Terminal for serial connection
P	GND	Ground Terminal

### 3.3 HV BOX Overview

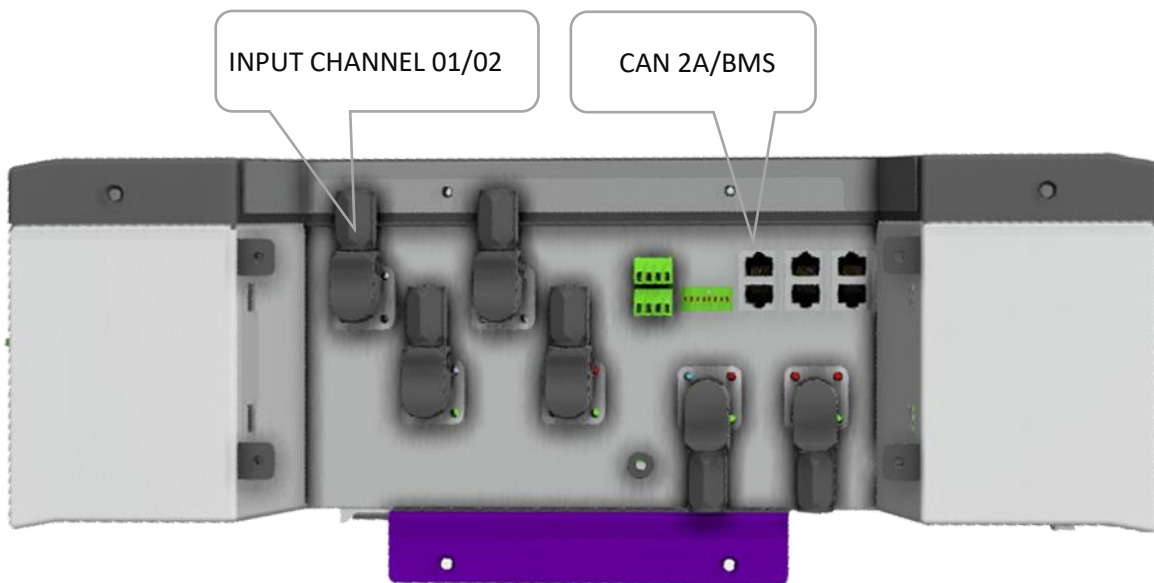
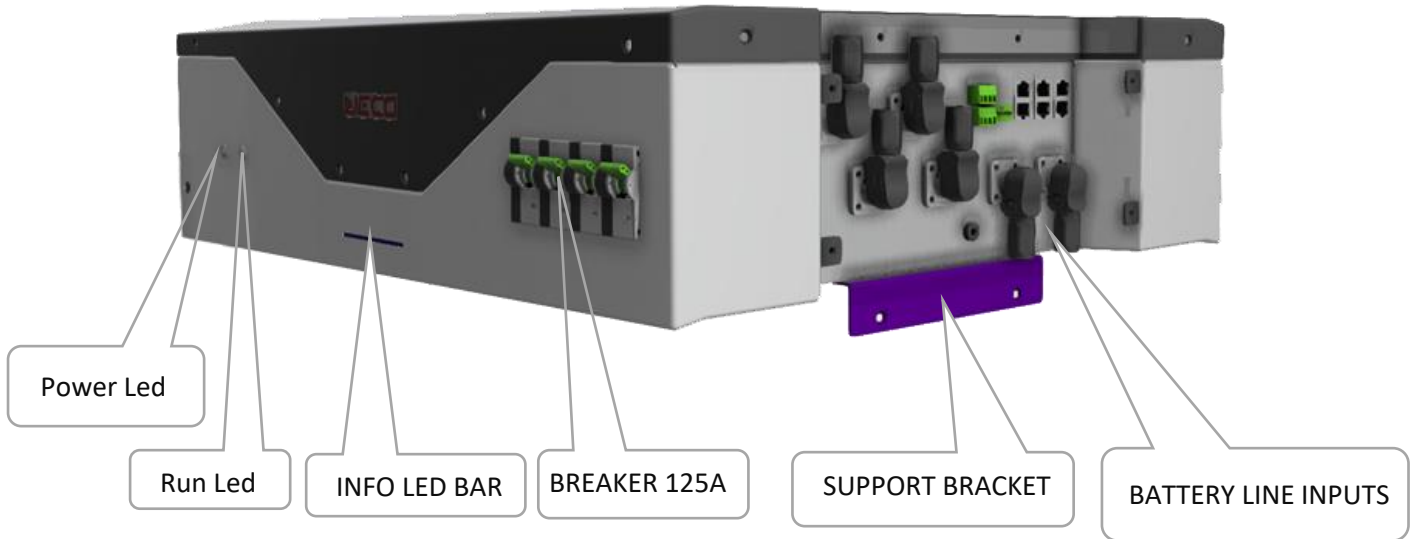

**HV BOX Terminals Definition Table**

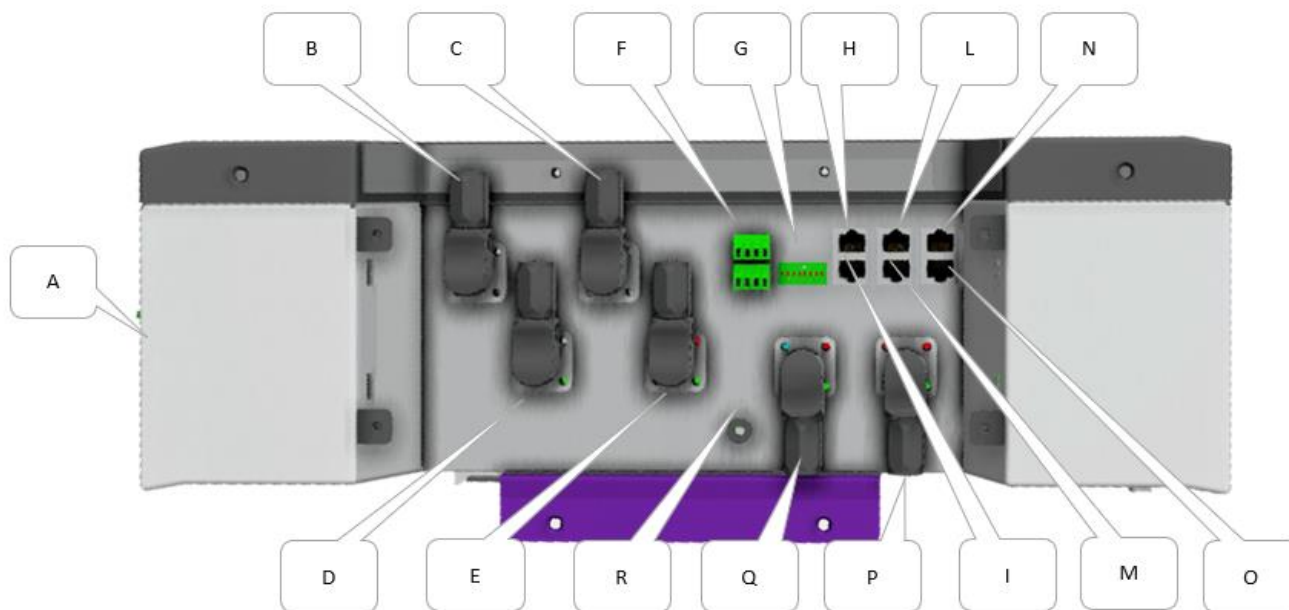

**HV BOX Definition Table**

Interface	Name	Function
A	WIFI ANTENNA	WiFi ANTENNA * (Optional)
B	INPUT CHANNEL +	POSITIVE INPUT FROM THE INVERTER CHANNEL 01 POSITIVE PLUG (+) MAX 50A
C	INPUT CHANNEL -	NEGATIVE INPUT FROM THE INVERTER CHANNEL 01 NEGATIVE PLUG (-) MAX 50A
D	INPUT CHANNEL +	POSITIVE INPUT FROM THE INVERTER CHANNEL 02 POSITIVE PLUG (+) MAX 50A
E	INPUT CHANNEL -	NEGATIVE INPUT FROM THE INVERTER CHANNEL 02 NEGATIVE PLUG (-) MAX 50A
F	D/I – D/O	Digital Input / Digital Output (Both Terminals are programmable via PC Software)
G	DIP TERMINAL	DIP SWITCH TERMINAL (Address)
H	CAN PORT 2-A	RJ45 CAN 2-A PORT (Inverter interface)
I	CAN PORT 2-B	RJ45 CAN 2-B PORT (Line for connection with SUB HV BOX)
L	CAN PORT 1-A	RJ45 CAN 1-A PORT
M	CAN PORT 1-B	RJ45 CAN 1-B PORT (Connection with the First battery Module)
N	OPERATOR PORT	OPERATOR PORT FOR RS232/USB converter
O	LINK -B	NOT USED
P	BATTERY INPUT +	POSITIVE CONNECTION FROM THE POSITIVE TERMINAL OF THE BATTERY
Q	BATTERY INPUT -	NEGATIVE CONNECTION FROM THE NEGATIVE TERMINAL OF THE BATTERY
R	GROUND	GROUND TERMINAL

**Attention:** Interface E: RJ45 PORT corresponding to the CAN bus pin definition

	Pin	8	7	6	5	4	3	2	1
	Definition						GND	CAN L	CAN H

### 3.4 High Voltage Module Configuration



ATTENTION: The High Voltage mode mandates that the Battery Modules must be connected in series.



ATTENTION: The following table provides the possible module configurations. NO OTHER configurations are permitted.



ATTENTION: Before connecting an HV inverter with the HV BOX terminal, always check the inverter input range. (Min and Max Voltage).



ATTENTION: a serial connection cluster is efficient only if all battery modules are individually fully charged in LOW VOLTAGE up to SOC 100%, this process will allow a proper equalization between modules of the same cluster. The HV string preparation is an important step of the commissioning of an HV system, the installation of an HV system must include the equalization of the tower before delivering to the end user.

5K3-XP HV Box Type A 80-750Vdc + HV Inverter (always check the Operational Voltage range of the inverter)				
Tower -1	n°	Min Vdc	Max Vdc	Capacity kWh
Ingeteam Play TL Min Start Up Voltage	2	96	118	10.2
Other HV Inverter modules in series  (Ingeteam PLAY TL max 7 modules in series)	4	200	233.6	20.8
	5	250	292	26
	6	300	350.4	31.2
	7	350	408.8	36.4
	8	400	467.2	41.6
Tower -2	n°	Min Vdc	Max Vdc	Capacity kWh
Modules in Series	9	450	525.6	46.8
	10	500	584	52
	11	550	642.4	57.2
	12	600	700.8	62.4
	13*	650	759.2	67.6
	14*	700	817.6	72.8
	15*	750	876	78
	16*	800	934	83.2

**ATTENTION**

(\*)Yellow Marked Voltage Range are possible only with the **Type B HV BOX** that has a voltage input starting from 150V up to 1000Vdc.



**ATTENTION**

For the calculation of the energy of a cluster (in both LV and HV systems) the nominal capacity of a battery is generally considered as 5.2 kWh as a result of the multiple connection discrepancies, and imbalances between batteries.

### 3.5 High Voltage DIP Switch Settings



**ATTENTION:**



ALWAYS CONFIGURE THE DIP SWITCH SETTINGS BEFORE CONNECTING ANY POWER CABLES TO THE BATTERY HV TERMINALS.



WHEN CHANGES HAVE BEEN MADE TO DIP SWITCH SETTINGS, THE BATTERIES MUST ALWAYS BE RESTARTED FOR THE CHANGES TO TAKE EFFECT.



POWER CABLE CONNECTIONS MUST BE MADE IN STRICT ACCORDANCE WITH THE INSTRUCTIONS IN THIS MANUAL. INCORRECT POWER CONNECTIONS CAN DAMAGE THE BATTERY AND CAUSE INJURIES.



**ATTENTION:** All drawings are for reference only. Always refer to the physical product as the standard. If the manual does not match the physical product, stop all actions, remove any connections and store the batteries in a safe place. Call your WeCo technical representative for assistance.

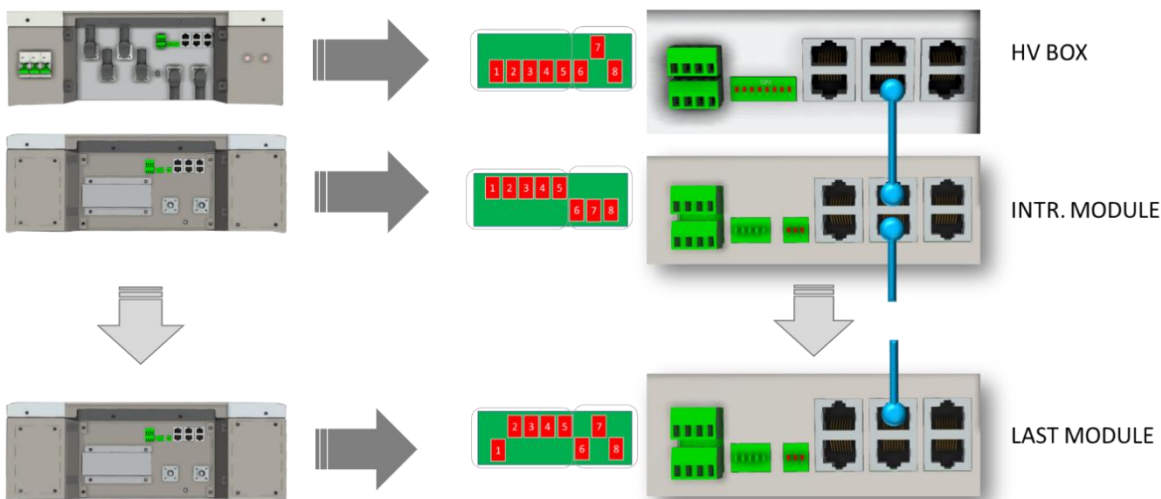

### 3.5.1 Serial Tower Connection #1 Set-Up of the HV Box CAN Communication Loop

Four batteries connected in series is the suggested minimum configuration for High Voltage operation:

**CAUTION:** After setting the DIP switches, the batteries must be restarted for the DIP switch changes to take effect.

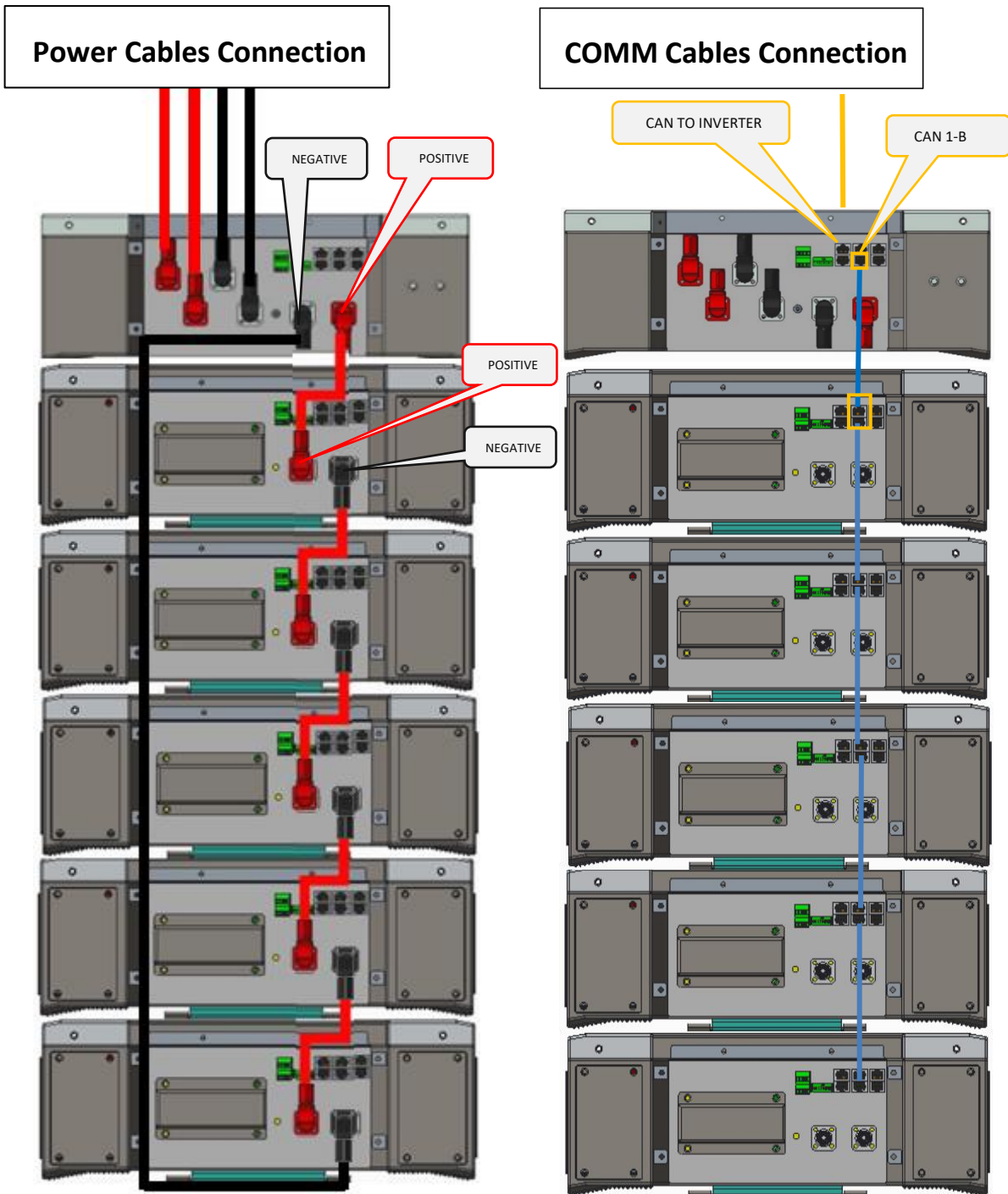

H  
I  
G  
H  
  
V  
O  
L  
T  
A  
G  
E

### 3.6 Serial Battery Wiring Connections

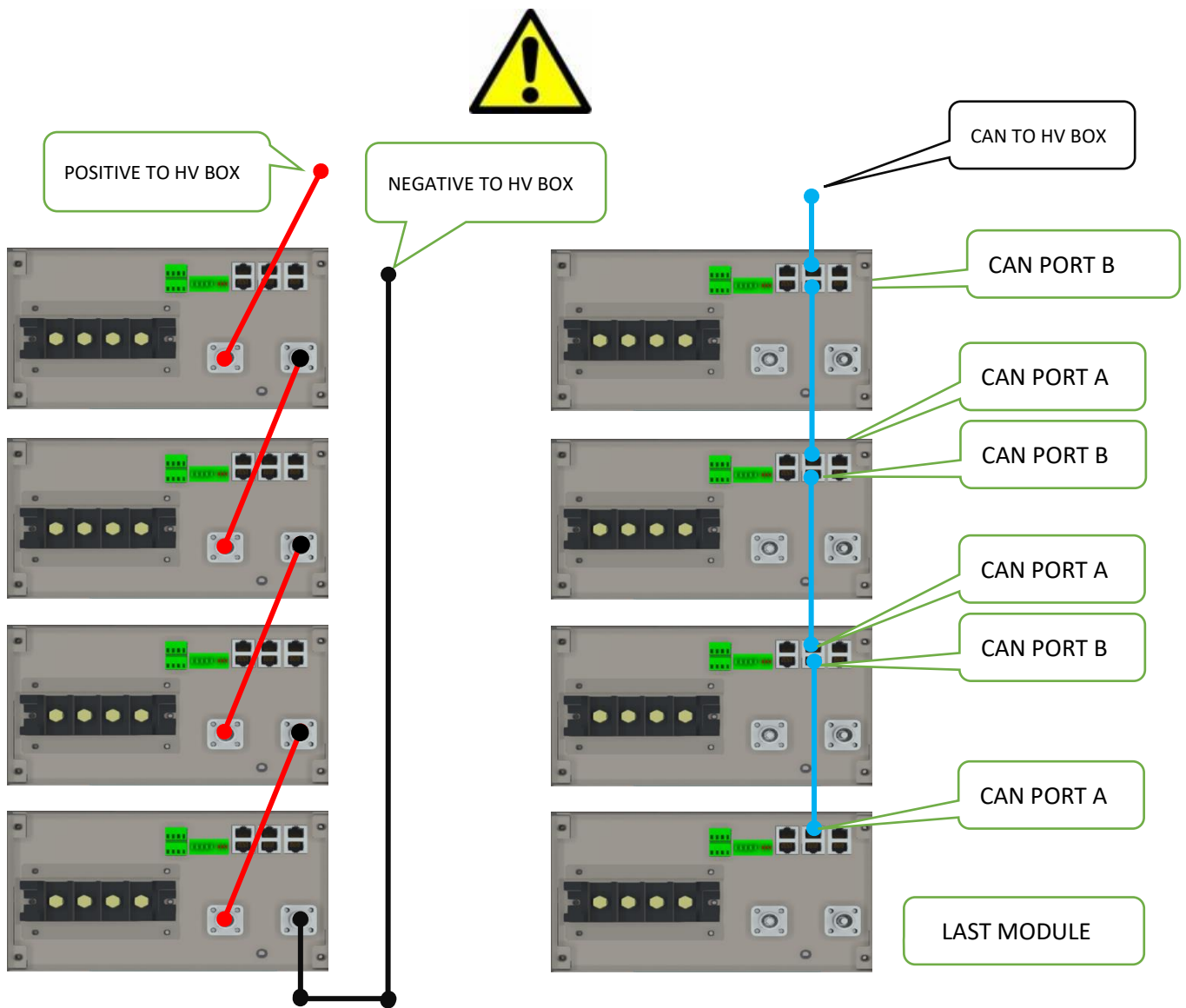

H  
I  
G  
H  
V  
O  
L  
T  
A  
G  
E



**POWER CABLE CONNECTIONS MUST BE MADE IN STRICT ACCORDANCE WITH THE INSTRUCTIONS IN THIS MANUAL. INCORRECT POWER CONNECTIONS CAN DAMAGE THE BATTERY AND CAUSE INJURIES OR SERIOUS DANGER AND DAMAGES**

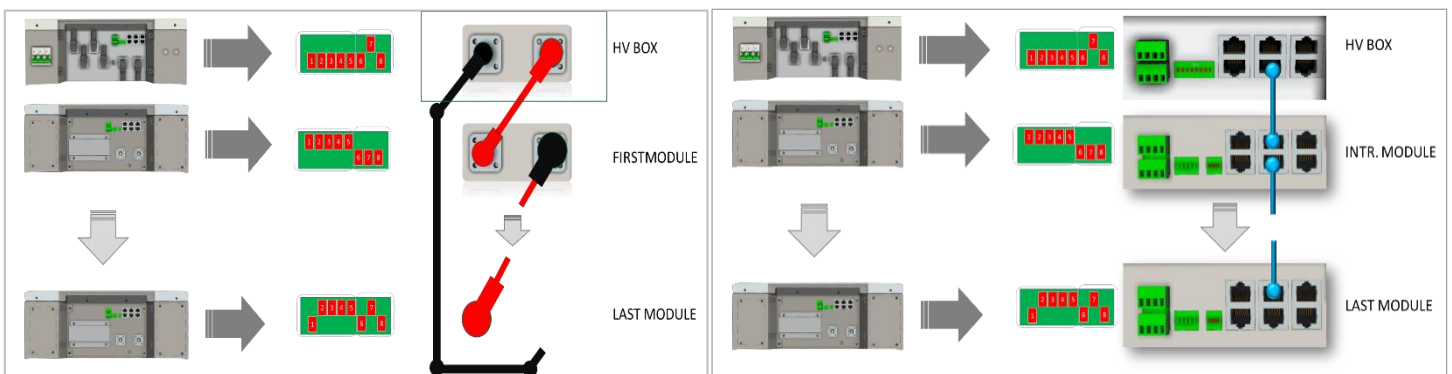



**ATTENZIONE**

When there are two towers that are part of the same cluster, the connection sequence must be respected as indicated.

From the top to the bottom of each tower, returning the polarity in SERIES.

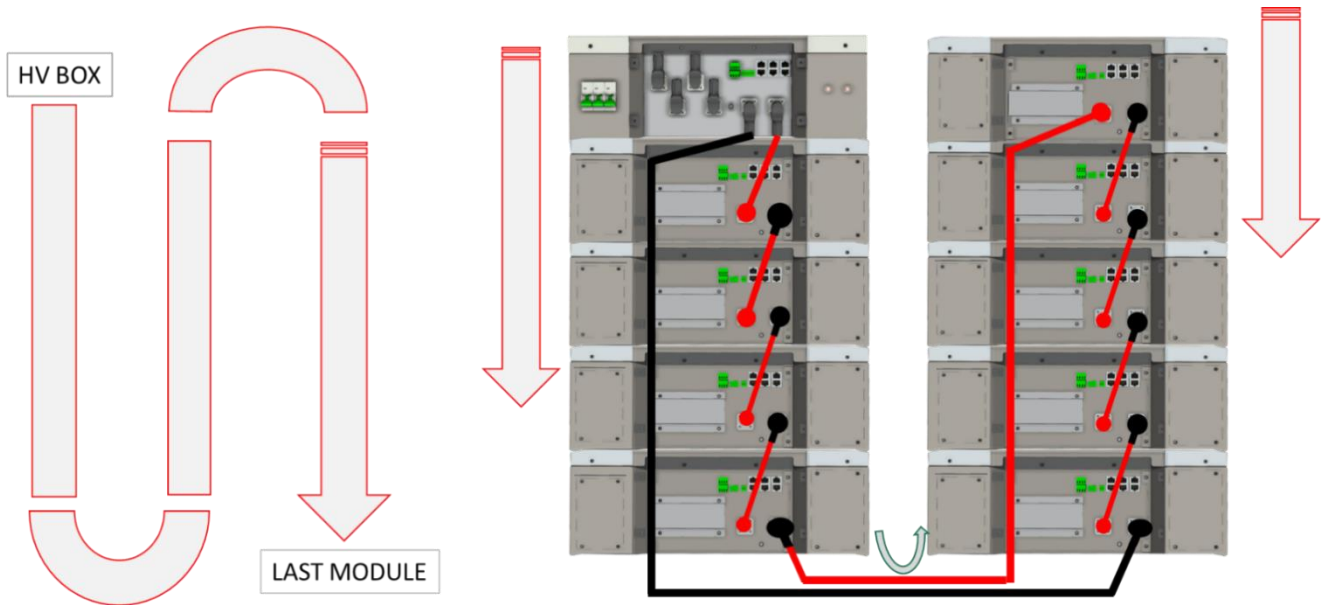

H  
I  
G  
H  
  
V  
O  
L  
T  
A  
G  
E



**Attention:** Screws, Cables and Bus Bar POWER CONNECTIONS must be installed with due diligence. Tightening torque refers to the use of a single standard bus bar or cable lug terminal; if using several overlapping or non-standard bus bars/terminals, check screw length  $\geq 16\text{mm}$ .



**Attention:** All drawings are for reference only; always refer to the physical product as the standard. If the manual does not match the physical product, stop all actions, remove any connections, store the batteries in a safe place and call your WeCo technical representative for assistance.



**Attention:** For power cable connection for high current connection diagram, please refer to the specific section. Charging current limitation is mandatory as per this instruction manual.



**Attention:** Do not use anything other than WeCo supplied power and data cables.

### 3.6.1 High Voltage Power Connections

5K3-XP HV Box can support maximum of 16 modules (934Vdc string Voltage).

Proceed with the physical installation of the desired quantity and configuration of the Battery Modules, following the installation sequences and guidelines as described in Section 1 of this manual.

Connect the power cables as indicated, making sure that the batteries are switched OFF (check the power switch on the side).

Do not connect the HV Box to the inverter input cables and do not turn on the HV Box breaker before serial connection completion.



Do Not Connect the Inverter until the HV Box is completely set up



Do Not Connect the HV Box with the inverter at this stage

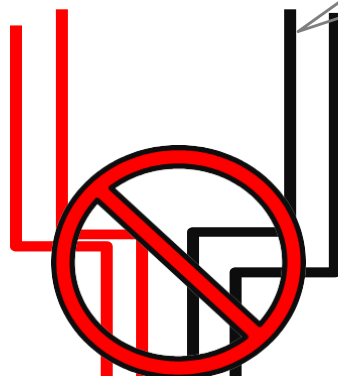

Keep the Breaker OFF

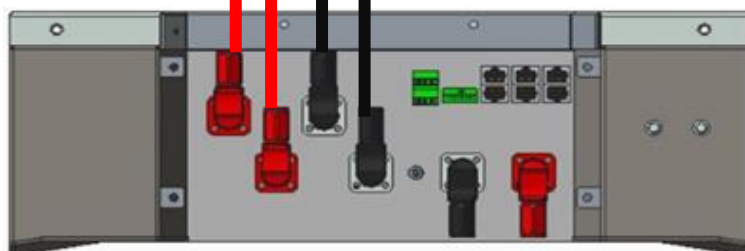

Connect the power cables and close the circuit between the HV BOX and the inverter before starting the HV BOX in order to allow the HV BOX pre-charging procedure. The pre-charge phase is designed to eliminate overcurrent damage from the batteries to the inverter during the start-up phase.

### 3.6.2 DATA Connections (Example of 12-Modules)

**Step 1:** Set up the DIP Switches as per the picture below.

**Step 2:** Connect the CAN PORTS, starting from the HV Box PORT CAN A, then chain connection as shown below.



The HV Box must be set up before turning it on. The DIP addresses must follow the picture below to enable the CAN communication. The last module of the series must be terminated by addressing the module as shown in the picture to end the CAN line.



Single HV Box

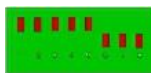

Battery Module



End Module

**Step 3:** Link all modules and the HV Box with 16 mm<sup>2</sup> earthing cables (In/Out) by using the GND connections point.

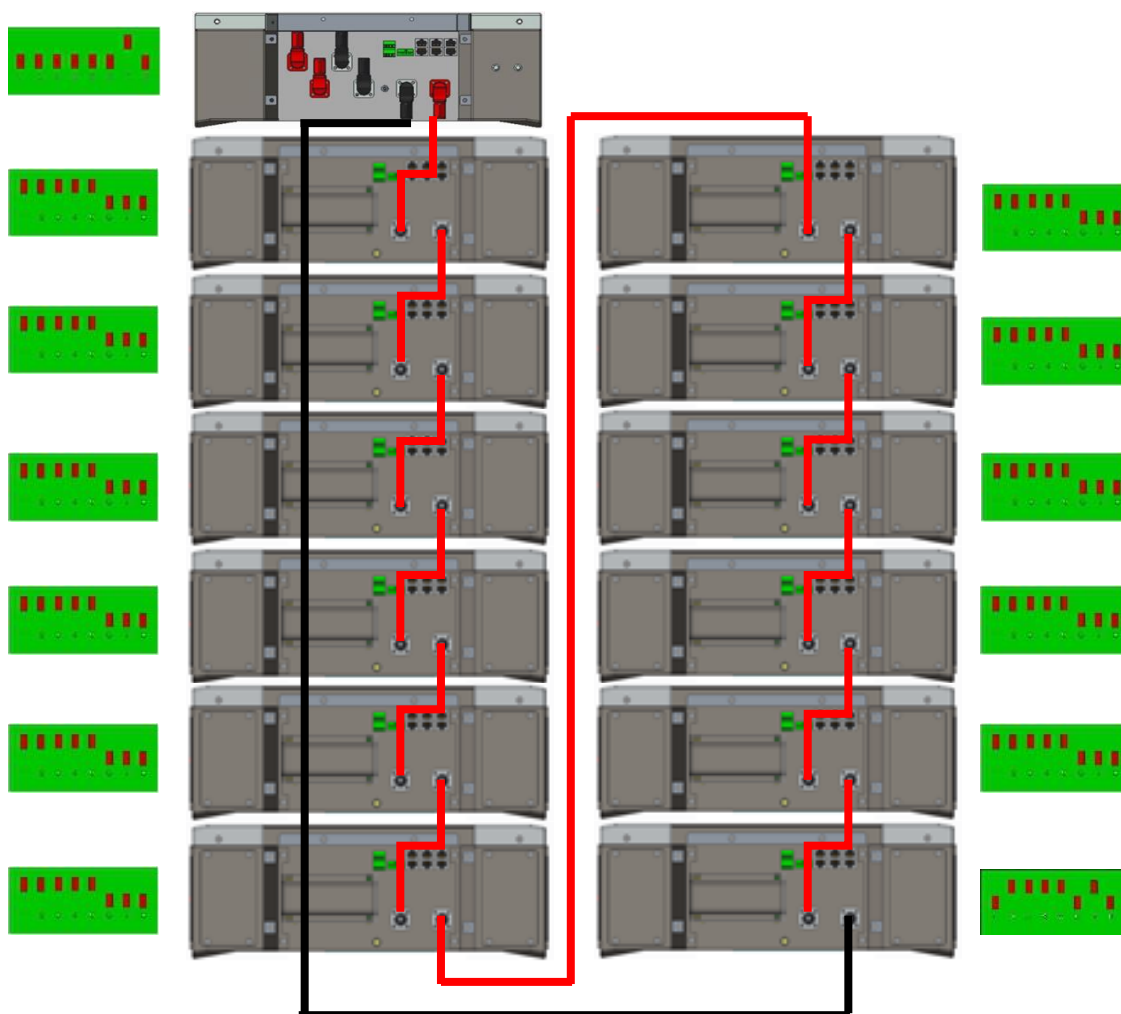



Make sure that the ground connection is not shared with other potential distributing devices and that the ground rod is not used for Neutral Line dispersion or Harmonics mitigation circuit.

Use the inverter GND line

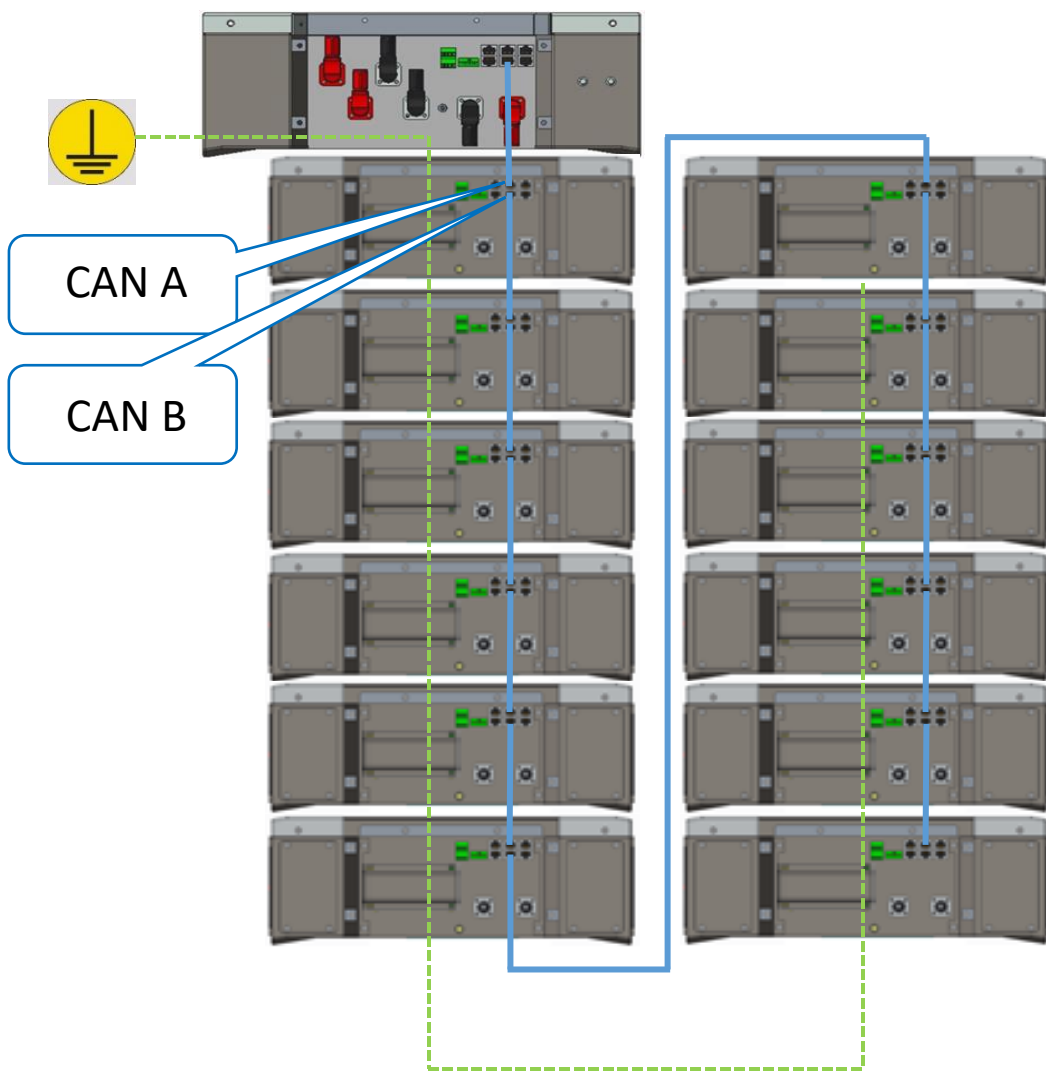

CAN Communication Ports between HV BOX XP and 5K3 XP in HV setting

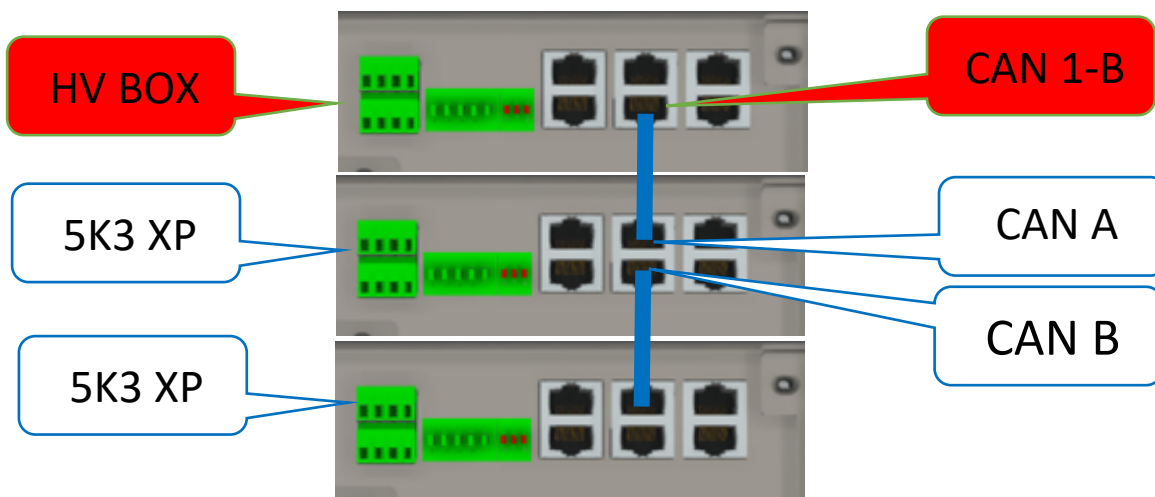

### 3.6.3 HV Box and Battery Module Power Connection

**Step 1:** Keep the HV Box XP MAIN BREAKER OFF.

**Step 2:** Connect the positive terminal of the HV Box to the Positive terminal of the 1<sup>st</sup> Battery Module.

**Step 3:** Proceed with the series connection between all the modules.

**Step 4:** Connect the negative output from the last module to the negative input of the HV Box.

**Step 5:** Connect the Inverter Input Channels to the inverter (follow the inverter manual).

**Make sure the DC circuit between inverter and HV is connected and ready to be closed as the pre-charge function will be effective only if the power connection between inverter and HV BOX is established.**

The Pre-Charge function has the function to protect the Inverter from Inrush current to the Capacitor bank of the inverter.

#### ATTENTION:

**THE DC DISCONNECTOR OF THE PHOTOVOLTAIC LINE MUST BE OPEN TO AVOID MEASUREMENT ERRORS OF THE RESISTANCE INSULATION**

**Step 6:** Turn on the HV Box breaker and wait for the start-up automatic procedure.

- 1- ID assignment
- 2- Insulation Tester (Fail below 300kOhm / 20 sec)
- 3- Pre-charge 150 Ohm / 4 Sec / Vnom
- 4- DC positive contactor Engaged
- 5- DC Negative Contactor Engaged (if included)
- 6- Pre-charge Contactor Disabled



**PHOTOVOLTAIC DC BREAKER MUST BE OFF**

**Step 7:** The HV Box will end the startup procedure within 90 seconds by closing the input circuit. The RED and the GREEN light of the HV BOX XP will turn on.

**Step 8:** Each module will turn on automatically and the side button will blink for 3 seconds, then a fixed GREEN light will confirm the run status of each module.

**If one or more modules do not turn on automatically, it is necessary to check all the COM CAN connections and restart the "START UP" procedure.**

**ATTENTION:** In the event of missed communication between the inverter and HV BOX for more than 200 seconds, the HV BOX will enable the safety procedure by opening the POWER CONTACTOR.

During the commissioning phase the installer must ensure that the communication between the HVBOX and the Inverter is correctly connected.

Do not leave the system powered in absence of communication between the HV BOX and the Inverter, a prolonged standby of the cluster could cause an imbalance caused by the natural self-discharge.

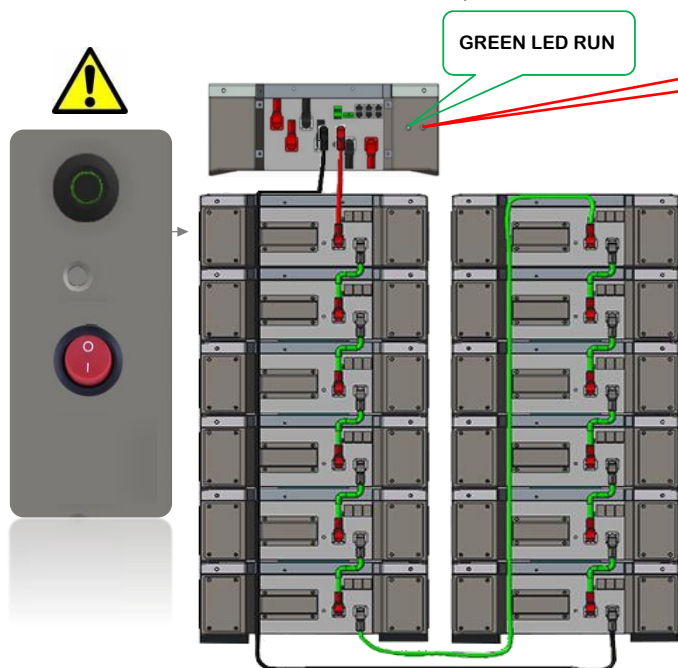

#### In the event of a SYSTEM FAULT

It is mandatory to:

- Pull down the HV BOX Breaker (**HV BOX OFF**)
- Shut Down the inverter (see inverter manual)
- Wait 10 min for the capacitors to discharge
- Isolate the Inverter from the HV BOX (unplug the power cables from the fast connectors)
- Unplug the CAN cable from the inverter / HV BOX
- Check all the connections of the cluster
- Turn on the battery cluster as stand-alone (not connected with the inverter)
- Connect the PC via RS 232 and by using the WECO XP MANAGER and identify the error if present (contact WECO for further support)
- If there are no errors as stand-alone need to repeat the same procedure above by connecting the inverter to the HV BOX (see start-up process)
- Keep the WECO XP MANAGER connected to the HV BOX, start up the inverter first (Keep the PV breaker OFF), and then start up the HV BOX. The PC SOFTWARE will identify the error if any.
- In case of missed CAN communication between the inverter and HV BOX the XP MANAGER will display EXT COM FAIL
- In case of LOW INSULATION, the XP manager will display R-ISO LOW. For troubleshooting and support please contact WECO (service@wecobatteries.com)

**Information:** Arrange the cables according to the specific installation requirements, always paying attention to minimize the length of the cables to avoid voltage drops.

Note: if the system is composed of more than 6 modules, it is required to arrange them as per the image.

**Different arrangements are strictly prohibited.**

### 3.6.4 Single HV Box Connection to an Inverter

**Step 1:** Turn the HV Box off by switching off the MAIN BREAKER located on the right side.

**Step 2:** Turn the Solar Inverter OFF.

**Step 3:** Connect the RJ45 cable into the CAN PORT 2A and perform the connection as per the Inverter Manual by following the PIN layout provided below. Make sure the CAN L and CAN H are matching the Inverter Terminal.

**Step 4:** Connect the Power Inputs from the inverter into the H+ and H- terminals.

**Step 5:** Turn on the HV Box main breaker.

**Step 6:** Wait for the startup completion of the power box (GREEN LED) and then turn on the Inverter.

#### Connection and Settings for HV Box

SINGLE CLUSTER WITH CAN ADDRESS 00

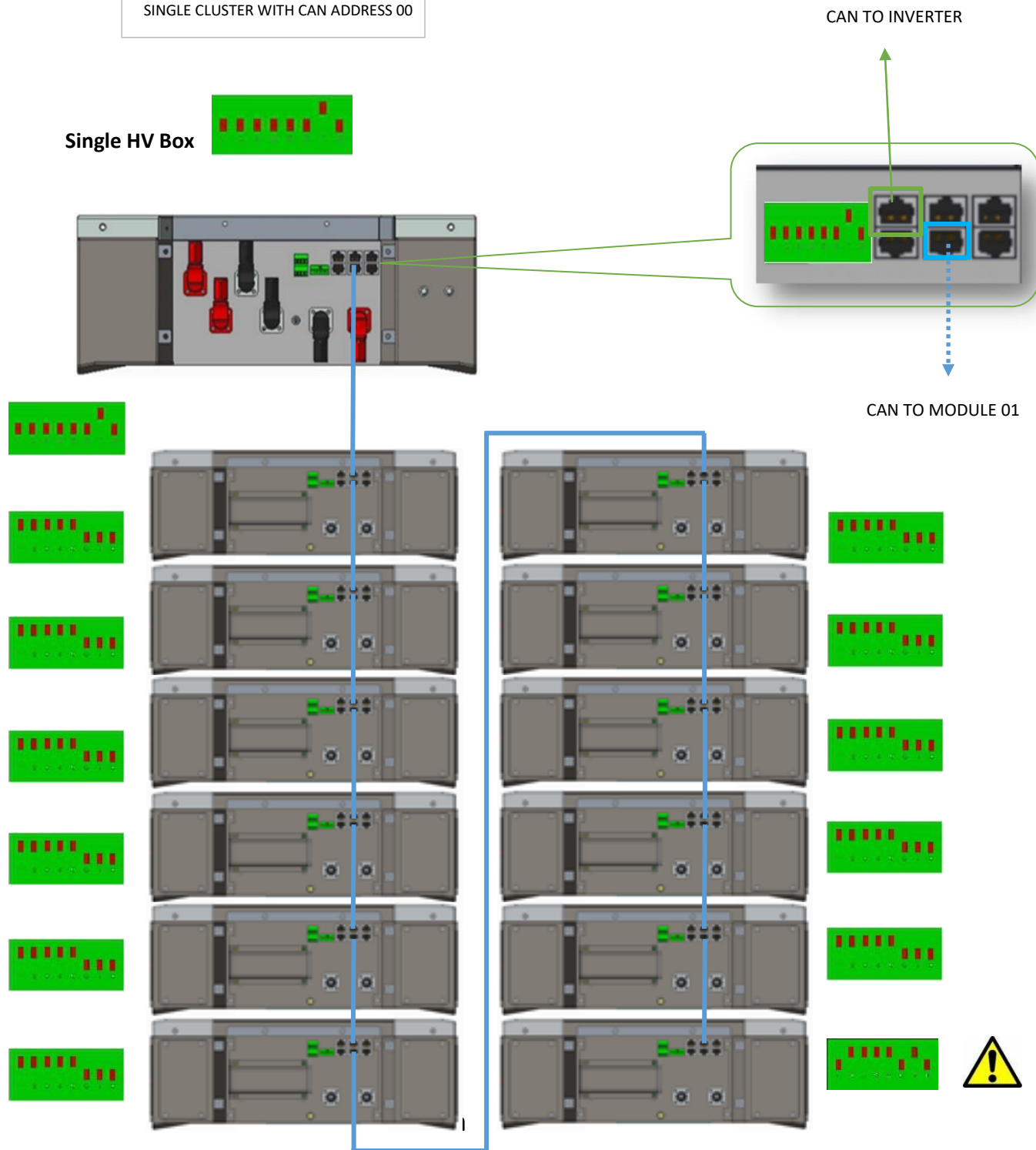

H  
I  
G  
H  
V  
O  
L  
T  
A  
G  
E

## Multi HV Box Connection SINGLE BRANCH CONNECTION

### Multi Clusters Communication Cable Connection

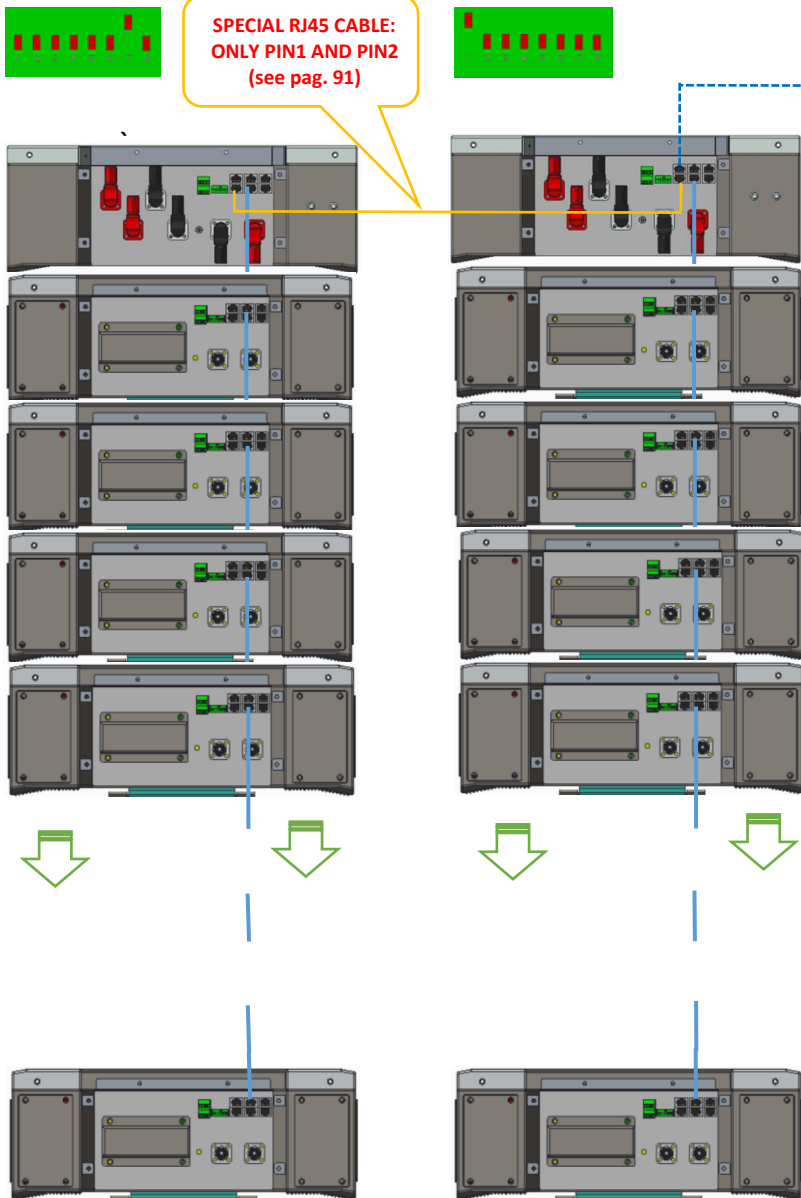

CAN TO INVERTER



### ATTENTION

When there are TWO HV BOX installed under the same Inverter CAN INPUT it is necessary to SET the inverter addresses inputs to identify two batteries on two separate channels.

The inverter must be set to recognize the two addresses of the HV BOX as ID 00 and ID 01.

DO NOT SET ANY OTHER ACCESSORY WITH CAN ID 00 and ID 01 as will conflict.

ALWAYS CHECK THE INVERTER MANUAL BEFORE STARTING THE SET UP PROCESS OF THE INVERTER.

Last

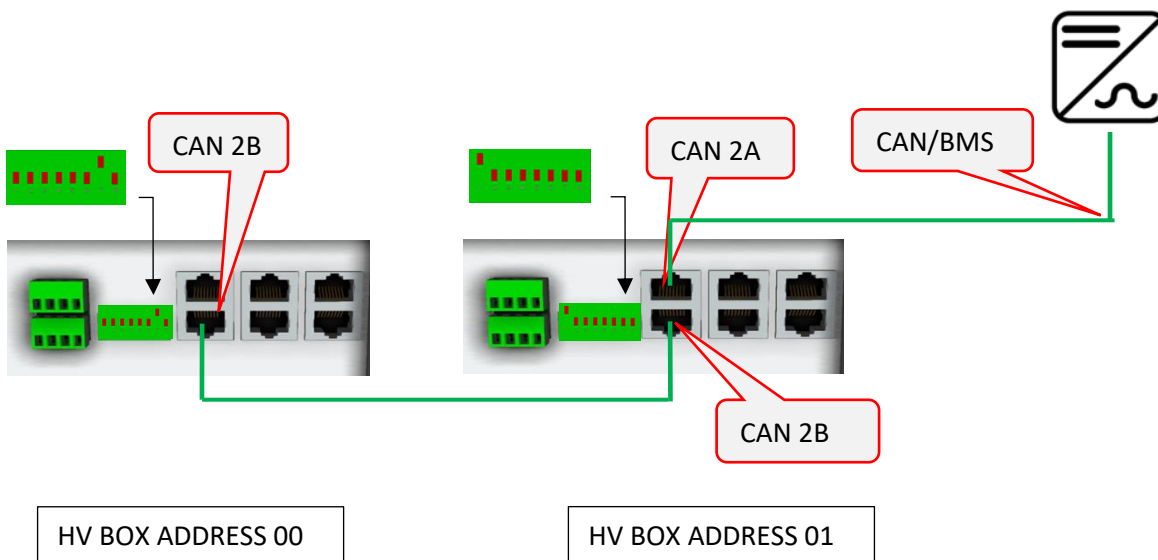

HV BOX ADDRESS 00

HV BOX ADDRESS 01

## With more than Two HV clusters it is compulsory to use the HV HUB as CAN COMBINER Multi HV Box Connection

### General Instructions

In a Multi Cluster Connection with only one inverter CAN Connection Line, it is necessary to use the HV HUB and connect in Daisy Chain all the HV BOXES of each Cluster.

When more clusters are connected together, it is necessary to use an HV HUB combiner to collect all the battery information and transfer it to the CAN inverter.

The CAN communication between the various HV BOXES has to be in Daisy Chain, starting from the HV BOX address 00 until the last module.

The last HV BOX needs to be connected via CAN to the BMS Port of the Inverter.

**In HV, it is possible to connect up to 10 Clusters composed of 13 or 16 modules each, according with HV BOX Voltage Input limit. (Max 8 cluster with DT8-24).**

After composing the various clusters of the system by following the instructions on the previous pages, it will be necessary to set the addresses of each HV BOX starting from address 00 and continuing in sequence up to address 16.

### HV CLUSTERS CONNECTION STEPS

1. Connect the last HV BOX with the HV HUB via the CAN PORT 2A of the end of series HV BOX and the CAN INPUT PORT of the HV HUB.
2. Set the DIP Switches of the HV HUB with the sequence 00000000. (ID 00) to the inverter CAN input.
3. Stack the HV HUB on top of the last cluster HV BOX and power it from the AC power supply 230Vac -12Vdc provided.
4. Connect the CAN PORT 2A from the last HV BOX to the CAN INPUT PORT of the HV HUB.
5. Proceed connecting the CAN PORT 2B of the last HV BOX to the CAN PORT 2B of the previous one up to the first HV BOX.
6. Connect the CAN/BMS PORT of the HV HUB to the Inverter BMS PORT (follow the inverter manual for PIN OUT of the CAN L/H position).
7. Initiate the HV CLUSTER Start-Up procedure by following the Single Cluster procedure for each cluster in the System.
8. To enable the HV Start-Up procedure, it is necessary to SWITCH ON the Main Breaker of the HV BOX. Before doing this, it is compulsory to inspect all the power connections of each cluster and the common HV bus bar.
9. All the SUB MODULES of each cluster will automatically WAKE UP after enabling the HV BOX main Breaker.
10. During the Cluster Start-Up process the HV HUB POWER LED LIGHT will blink until the last cluster is completely turned on and all modules will display steady GREEN Light on the RUN BUTTON.

If one or more modules of the cluster does not come online, the cluster HV BOX will send a WARNING message to the HV HUB and the entire system will enter into IDLE MODE. To clear this status, it is necessary to inspect the modules that are causing the wake-up interruption, fix the error and repeat the entire Start-Up process from Step 1 (All HV BOXES must be Turned OFF and ALL Modules must be switched OFF before restarting the procedure).



## ATTENTION

### DO NOT RECHARGE A SINGLE MODULE FROM THE HV TERMINALS, ONLY USE THE LOW VOLTAGE TERMINALS

It is extremely important that every module within the cluster has the same voltage.

Before creating an HV cluster it is mandatory to fully charge each individual module from the LV terminals

The installation of an HV System is very complex and requires particular attention to the preparation of the individual modules that make up the cluster.

A single module with a voltage lower than a few mVolts compared to the others could generate a performance reduction of the entire system.

Fully charge each single module up to 100%, after 30-40 minutes the voltage will drop to around 53,5Vdc, this is a normal behaviour of the LiFePo4 Chemistry, when the voltage of all modules is consistent it is possible to make up the HV cluster.

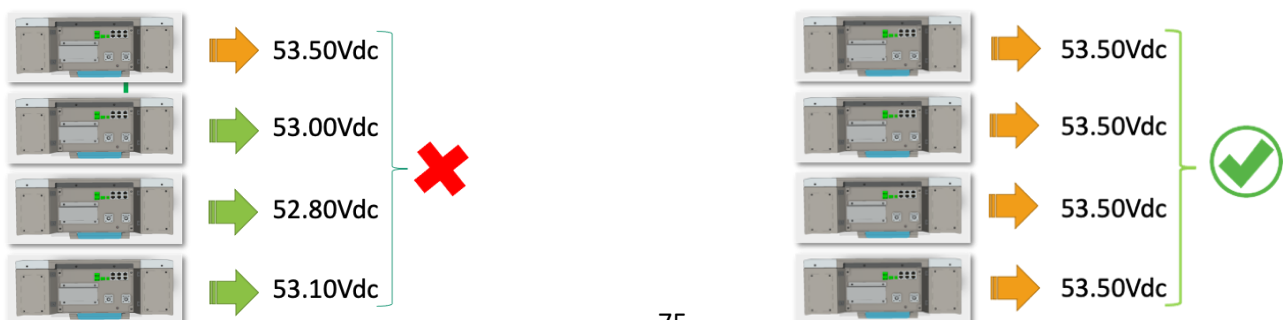

## Preconditions

The cluster must be loaded in HV up to 100% shown on the inverter display.

Once 100% is reached, even after the jump of SoC, it will be possible to proceed as follows.



Turn off the HV BOX by acting on the disconnector  
 Disconnecter positioned on OFF  
 Remove the power cables and the connection cables between batteries



Release the HV connectors  
 Each HV cable must be removed



Remove the metal protection of the LV terminals  
 Set the battery DIPs (formerly as LV master)



Connect a 10 Ampere charger  
 Activate the battery and wait for the contactor to intervene  
 Once 100% is reached (OverVoltage protection of the contactor)  
 proceed with charging the next battery



  
**ATTENTION**  
 Never recharge from the high voltage terminals



### ATTENTION

It is always recommended to prepare the battery modules that make up an HV cluster as indicated above, before starting the high voltage system.

In the case of a corrective action on an existing system, at the end of the operations reassemble the tower by connecting again the HV cables between batteries and then to the HV BOX.

Start the high voltage system as indicated in the manual.

### 3.6.5 HV BOX SHUT DOWN PROCEDURE

#### ORDINARY SHUT DOWN PROCEDURE OF THE HV BOX

To turn off the HV BOX of any cluster connected to the inverter, it is mandatory to follow the procedure.

1. Turn off the PV INPUT from the inverter by turning the DC switch of the inverter.
2. If the DC switch is not integrated in the inverter, open the PV circuit of the inverter (fuse or string insulator).
3. Disable any charging or discharging process by adjusting the inverter settings or open the AC breaker and the load input breaker of the EPS and LOAD AC line.
4. Wait for the inverter to finish discharging the capacitors (see inverter manual.)
5. Turn off the HV BOX manual switch on the side of the HV BOX.
6. Wait 60 seconds and disconnect the power cables from inverter or from the HV BOX (quick connectors CH1 and CH2). All input cables coming from the inverter must be disconnected from the HVBOX.

#### MAINTENANCE AND / OR REPLACEMENT OF THE HV BOX in addition to the previous operations

7. Disconnect the Positive Input from the 1st battery to the HV BOX
8. Disconnect the negative input from the last battery to the HV BOX
9. Disconnect the CAN / BMS cable
10. Disconnect and the CAN cable
11. Loosen the support bracket from the first battery
12. Remove the HV BOX from its location

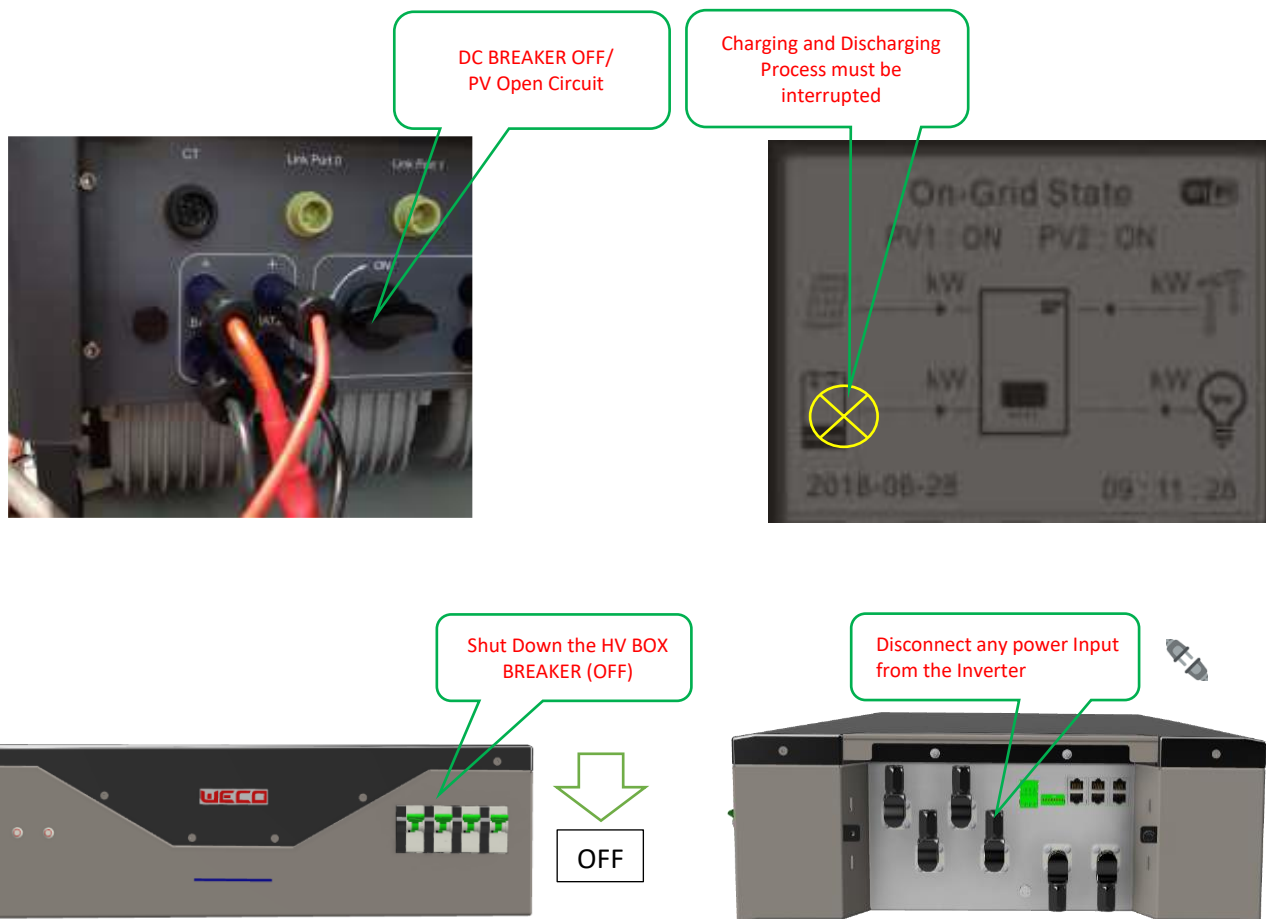

H  
I  
G  
H  
V  
O  
L  
T  
A  
G  
E

### 3.7 HV Box ADDRESS

	HV BOX ADDRESS	DIP1	DIP2	DIP3	DIP4	DIP5	DIP6	DIP7	DIP8		
	Adres after the setting	1	2	3	4	5	6	7	8		
DIRECT	0	HV BOX Address 00	OFF	OFF	OFF	OFF	reserved	reserved	ON-with Terminal resistance OFF-no Terminal resistance	reserved	
	1	HV BOX Address 01	ON	OFF	OFF	OFF	reserved	reserved	ON-with Terminal resistance OFF-no Terminal resistance	reserved	
	2	HV BOX Address 02	OFF	ON	OFF	OFF	reserved	reserved	ON-with Terminal resistance OFF-no Terminal resistance	reserved	
	3	HV BOX Address 03	ON	ON	OFF	OFF	reserved	reserved	ON-with Terminal resistance OFF-no Terminal resistance	reserved	
	4	HV BOX Address 04	OFF	OFF	ON	OFF	reserved	reserved	ON-with Terminal resistance OFF-no Terminal resistance	reserved	
	5	HV BOX Address 05	ON	OFF	ON	OFF	reserved	reserved	ON-with Terminal resistance OFF-no Terminal resistance	reserved	
	6	HV BOX Address 06	OFF	ON	ON	OFF	reserved	reserved	ON-with Terminal resistance OFF-no Terminal resistance	reserved	
	7	HV BOX Address 07	ON	ON	ON	OFF	reserved	reserved	ON-with Terminal resistance OFF-no Terminal resistance	reserved	
VIA HV HUB	8	HV BOX Address 08	OFF	OFF	OFF	ON	reserved	reserved	ON-with Terminal resistance OFF-no Terminal resistance	reserved	
	9	HV BOX Address 09	ON	OFF	OFF	ON	reserved	reserved	ON-with Terminal resistance OFF-no Terminal resistance	reserved	
	10	HV BOX Address 10	OFF	ON	OFF	ON	reserved	reserved	ON-with Terminal resistance OFF-no Terminal resistance	reserved	
	11	HV BOX Address 11	ON	ON	OFF	ON	reserved	reserved	ON-with Terminal resistance OFF-no Terminal resistance	reserved	
	12	HV BOX Address 12	OFF	OFF	ON	ON	reserved	reserved	ON-with Terminal resistance OFF-no Terminal resistance	reserved	
	13	HV BOX Address 13	ON	OFF	ON	ON	reserved	reserved	ON-with Terminal resistance OFF-no Terminal resistance	reserved	
	14	HV BOX Address 14	OFF	ON	ON	ON	reserved	reserved	ON-with Terminal resistance OFF-no Terminal resistance	reserved	
	15	HV BOX Address 15	ON	ON	ON	ON	reserved	reserved	ON-with Terminal resistance OFF-no Terminal resistance	reserved	

H  
I  
G  
H  
  
V  
O  
L  
T  
A  
G  
E

## MULTI CLUSTER CONNECTION HUB XP



### ATTENTION:

The connection between two HV BOX connected in Daisy chain through the CAN ports must imperatively be made with a specific two-wire RJ 45 cable.

**The communication cable must be made by crimping only PIN 1 and PIN 2**

All PINs between PIN 3 and PIN 8 must be left blank.

### TWO WIRES CONNECTION PATCH BETWEEN HV BOX AND COMBINER

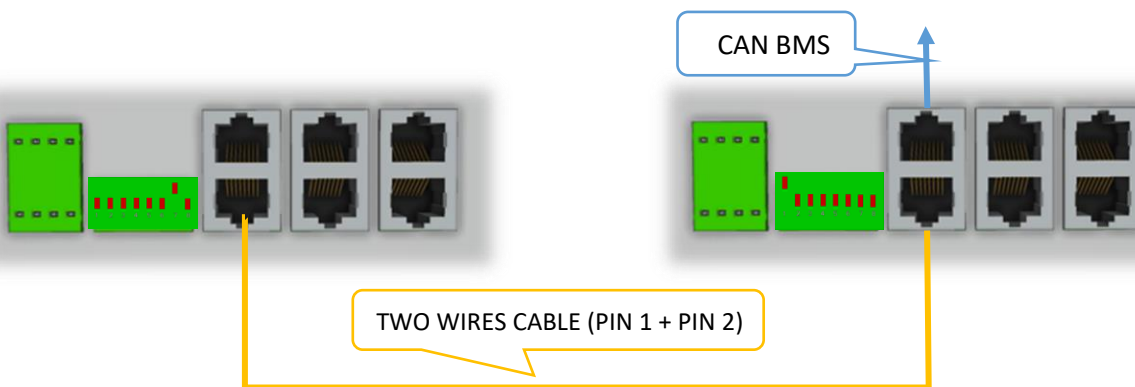

## MULTI CLUSTER CONNECTION WITH HIGH VOLTAGE HUB

### Installation of a High Voltage Multi-Cluster System.

1. Install clusters with the same number of modules. Each module of each cluster must have the same voltage.
  2. Each cluster must have the same total voltage.
  3. Set the DIP switches of each HV Box with the addresses starting from ID 01 and continue in progressive sequence up to the last HV Box.
  4. Connect the last HV BOX with the HV HUB device by connecting the CAN PORT 2A of the HV BOX with the CAN INPUT PORT located on the HV HUB.
  5. Proceed connecting the CAN PORT 2B of the last HV BOX to the CAN PORT 2B of the previous one up to the first HV BOX.
  6. Connect the CAN BMS PORT of the HV HUB device to the CAN PORT of the inverter following the inverter manufacturer PIN.
  7. Power the HV HUB device with the AC-DC power supply
- Attention: Do not turn on the HV HUB device (power key to be kept off)**

8. After checking all high voltage power connections and making sure polarity is correct, visually check all connections by double-checking the manual.
9. Turn on the Main Switch, (1) then Press the HV HUB power button (Green LED)
10. Activate the first switch of the HV BOX ID01 and wait for the total start-up of the first cluster. Only when the first cluster is fully operational is it possible to proceed with the start-up procedure of the second cluster.

11. Wait for the complete start-up and then proceed with the same methodology for each cluster.
12. At this point, the start-up procedure is completed and the HV HUB device will initiate the control procedure of each single cluster by activating the HV HUB contactors one by one to prevent voltage spikes.
13. The start-up procedure foresees the deferred switching on of the various clusters with a delay of at least 5 seconds from each other.

**ATTENTION:**

In a multi cluster system, all the HV BOXES will receive the input of closing the HV BOX contactor only when the entire cluster procedure is completed by the HV HUB.

HUB HV logic includes a voltage control algorithm that controls the consistency of each cluster before allowing the closing the HV BOX contactors.

The PC software will indicate any cluster mismatching that prevent installation.

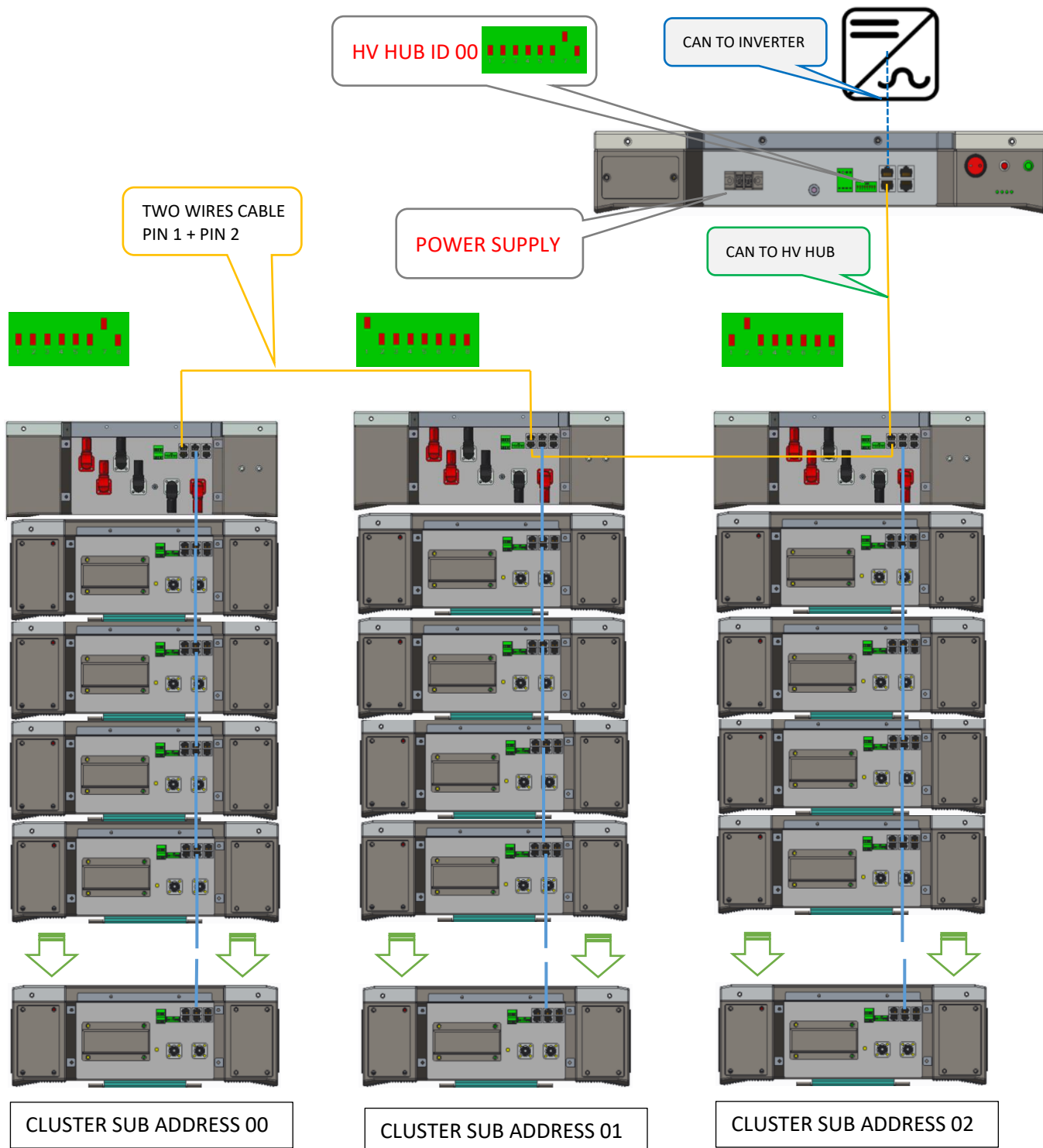

### 3.7.1 LED Visual Indication Lights of the HV BOX

- RUN Button.
- Each Battery Module has its own RUN button, however, when used with the HV Box during normal operation, the RUN button has no function and is bypassed by the control communications from the HV Box.



**Caution:** In the HV configuration, the RUN button will have no effect on the operation of the Battery Module and the operator should not assume that the RUN button will have switched off the Battery Module when pressed.

#### 3.7.1.1 Power Switch + Run Button

The Power Switch and the Run Button are located to the right of the battery terminal connections on the side of the Battery Module.

The RUN Button is a GREEN LED button and will provide the user with the following indications depending on the state of the battery.

**STARTUP:** Turn ON the Power Switch (1 = ON 0= OFF)

A 2-second press on the RUN Button will turn the Battery Module on.

During the startup procedure, the RUN button will blink until the safety inspection has been completed by the BMS.

**SHUTDOWN:** A 5-second press and hold on the RUN Button will turn the Battery Module off.

Turn OFF the Power Switch (1 = ON 0= OFF)

Other functions of the RUN Button are explained in the relevant sections of this manual.

**The RUN button of each module might Blink for several minutes after the HV BOX shuts down, this is part of the BMS logic: each module is waiting to receive confirmation from the previous module that no upgrade is ongoing, typically the shut down process could take up to 1 minute per each module connected.**



**Attention:** Read this entire manual thoroughly to understand the correct startup and shutdown procedures for each battery configuration.

As the modules are connected to the WECO CLOUD, some modifications of the of the ordinary procedure might change and could not reflect this manual.

The safety procedures will remain unchanged in any case.



**Attention:** Illustrations shown are for reference only. Please always refer to the physical Battery Module in front of you, and if the module has a different configuration to this manual, stop all activity immediately and contact your WeCo technical representative.

## 3.7.2 Stand-Alone Battery Front Panel Control \*FORCED CHARGE\*

### 3.7.2.1 Start Battery

Press the Power Button of the HV Box for 3 or more seconds (depends on the system status).

The GREEN RUN light should come on. The HV Box module has been activated normally and the Battery Modules should come on automatically. If they do not, press the RUN Button of each module and wait for the HV Box string diagnosis. If the HV Box shows a warning LED light (RED), turn the string OFF and connect the PC software for debugging.

### 3.7.2.2 Shut Down Batteries and HV Box

Long press the RUN Button on the battery module for five seconds and the Run Button on the HV Box.

Pull down the HV BOX XP breaker to shut down the HV BOX and the batteries.

The GREEN RUN light should go off. The HV Box has been shut down normally.

By switching off the HV Box, all the Battery Modules should turn off automatically.

If they do not turn off automatically, shut down manually by pressing and holding the Run Button on the battery module for 5 seconds and or by pressing the main switch in (0) position.

Always completely shut down the system when performing a mechanical or electrical inspection.

### 3.7.2.3 Low Battery – Forced Charge



#### ATTENTION:

The HV connection cables must be disconnected; the Forced Charge implies to follow the LV section rules.

**THE FORCED CHARGE MUST BE PERFORMED AS SINGLE LOW VOLTAGE MODULE.**

**THE MODULE MUST BE COMPLETELY DISCONNECTED FROM THE HV STRING.**

To set the forced charge set the dip switches as below and restart the battery

1. Press the RUN BUTTON 5 sec to turn off
2. Change the DIP switch and set it to ZERO (0)

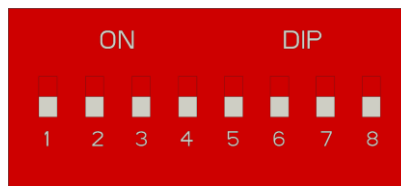

**ATTENTION:** Before performing any operation on the Battery Module, make sure that the **VOLTAGE** between the battery B+ and B- terminals in the terminal BLOCK LOW VOLTAGE SECTION is **ZERO (0 Vdc)** and the **PANEL LIGHTS ARE OFF**.

Only when Battery Module is in “Shutdown State”, the charging device can be connected. Then the operator can turn on the battery by pressing the Run Button.

**Each Battery Module must be electrically isolated from other Battery Modules. All serial connections cables must be removed.**

**Preparation condition before Forced Charging:** Connect a 60 Vdc 10A charger to the B+ and B- terminal of the of the Battery Module to ensure charging.

**Forced Charging approach:** By shortly pressing the Battery Module RUN Button, the RUN light will flash GREEN which means that the battery is entering the compulsory charging mode. If the battery receives an adequate charging power (above 10 Amps/58Vdc) within 90 seconds from pressing the button, the battery will continue to charge normally until a stable state is reached.

If the battery does not receive adequate charging power within 90 seconds after pressing the RUN button, the battery will enter the shutdown mode once again.

During the Forced Charging period, the FRONT LED BAR low battery LED will be steady orange up to an SoC of 10% at which point the FRONT LED BAR low battery LED will go out. Details of the indications on the FRONT LED BAR can be found in Section 2.5.5 of this manual.











**ATTENTION:** Each Battery Module must be recharged at the same SoC. The inspection must be done by using the WeCo RS232 and LV PC software or via BT app.

This process could take some time and will require either a portable PC or handheld computer device or a mobile phone with WeCo Apps.



**ATTENTION:** When the charging process of each module has been concluded, the serial connection must be restored by following this manual's instructions.

### 3.8 HIGH VOLTAGE INVERTER COMPATIBILITY

INVERTER BRAND		MODEL	HV BOX Protocol Selection
	AteSS	HV	ATESS CAN
	ZCS Azzurro	HYD ThreePhase ALL	WeCo CAN
	Sermatec	SMT ThreePhase ALL	WeCo CAN
	Tsun	TSOL HV single Phase	WeCo CAN
	Megarevo	Threephase ALL	WeCo CAN
	Solis	5G-K Threephase HV ALL	SOLIS CAN
	Ingeteam	INGECON HYBRID	INGECAN-HV
	Autarco	Threephase HV ALL	SOLIS CAN
	WeCo ESS	HYBO 120-240-480	WeCo CAN

#### CAN PIN DEFINITION FOR HV INVERTERS

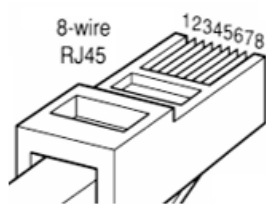
	CAN TERMINAL	Inverter Terminal Type	Invertr Side (PIN Number)	Battery Side (PIN Number)
ZCS THREEPHASE	CAN L	SCREW TERMINAL	8	2
	CAN H		7	1
	GND		/	3
SOLIS HV	CAN L	RJ45	5	2
	CAN H		4	1
	GND		2	3
TSUN HV	CAN L	RJ45	5	2
	CAN H		4	1
	GND			3
INGETEAM PLAY HV	CAN L	Inner Terminal	CAN H	1
	CAN H		CAN L	2
	GND		/	3
SERMATEC HV	CAN L	SCREW TERMINAL	CAN H	1
	CAN H		CAN L	2
	GND		/	3

### 3.9 DRY CONTACTS SETTINGS

The battery is equipped with dry contacts that allows to interact with external devices, other than the inverter to which they are connected.

This contact, referred to as DO2+ and DO2-, is accessible via the green connector located next to the battery DIP switches.



Using the PC software, you can define dry contact activation thresholds based on the % SoC value of the battery.

After connecting to the battery with the software using the installer password, simply go to the Setting page.

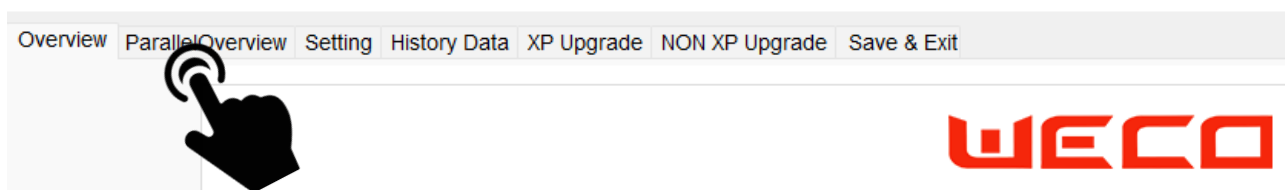

to display the DO Setting section.

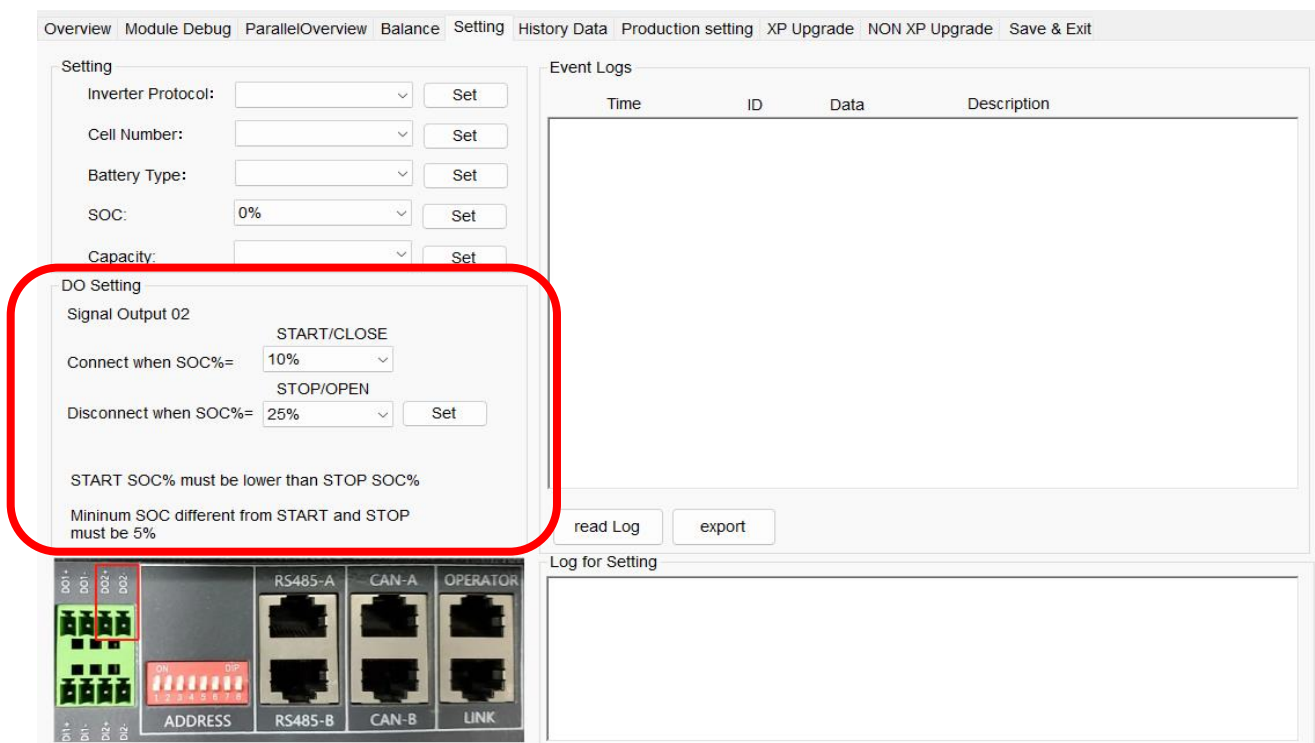

The dry contact DO2 (Digital Output 2) is a normally open contact, which can be set to close within a user-defined range through the setting of the closing and opening threshold.

**DO Setting**

Signal Output 02

START/CLOSE

Connect when SOC%= 10%

STOP/OPEN

Disconnect when SOC%= 25%

Set

START SOC% must be lower than STOP SOC%

Minimum SOC different from START and STOP must be 5%

Set the % SoC below which the contact should close

Set the % SoC above which the contact should open

Press SET to enable the settings.

The thresholds can be set freely in the range between 0% and 100%, respecting the following rules:

1. The SoC percentage for closing the contact must be less than the SoC percentage for opening.
2. The difference between the SoC percentages of close and open cannot be less than 5%.

TECHNICAL DATA

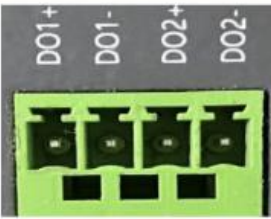
DO technical data	
	DO1 (DO1+, DO1-) not used; DO2 (DO2+, DO2-);
Type	Relay, dry contact
Voltage range	5 to 30V DC or 5 to 250V AC
Rated current (max)	2A
Lifetime mechanical (no load)	20,000,000 open/close cycles

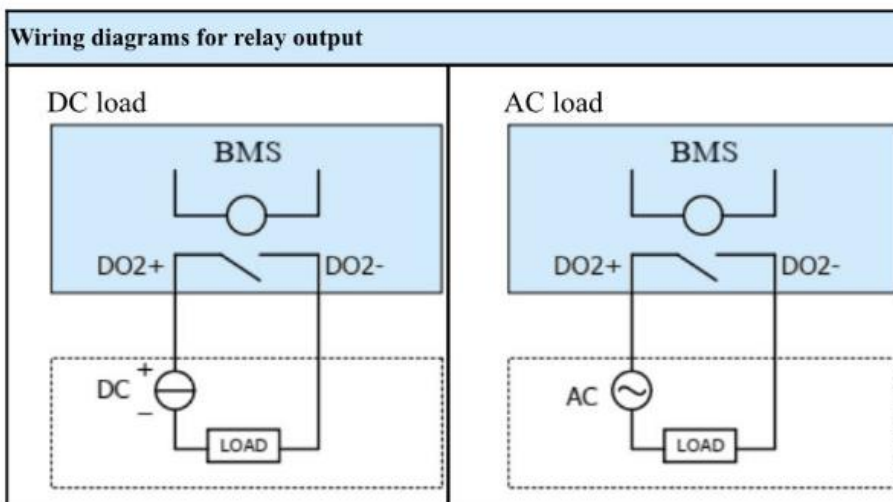

### 3.10 WECO BMS - LOW VOLTAGE PC SOFTWARE for 5K3-XP

#### **WECO MONITOR XP IS A SPECIFIC SOFTWARE FOR XP BATTERY TYPE**

##### LOW VOLTAGE SECTION

**Equipment List:**

PC Windows 10+Service pack 3.5 or above  
 RS232 Serial Converter with 232-RJ45 Plug  
 WeCo Monitor PC-SOFTWARE

**PIN OUT RS232 CONVERTER**

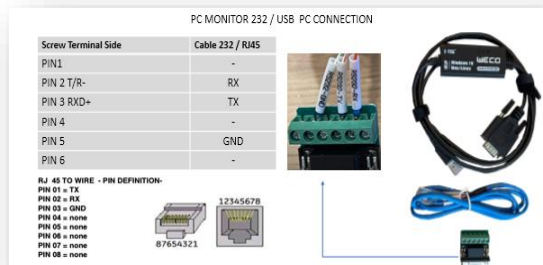

**STEP 1. Download the latest version of the WeCo BMS PC software at [www.wecobatteries.com](http://www.wecobatteries.com).  
 Enter the password: **1010**.  
 Click: Operator Access to run the program in -Operator Mode-**



**STEP 2. Select the Single Module Setting Program after pressing OPERATOR ACCESS Button.**

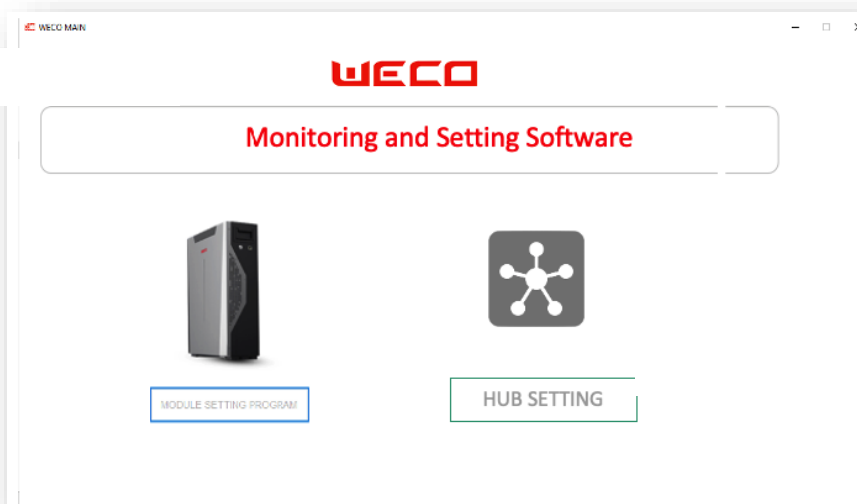

**STEP 3. Connect the RJ45 plug from the RS232-USB Converter to the Operator Port of the Battery Module.**

The module must be switched on. The Operator Port is located on the front panel.

Position Number 12345678

8-wire RJ45

RJ45,A side:								
No	1	2	3	4	5	6	7	8
colour	Orange	Orange	Green	Green	/	/	/	/
definition	RS232-TX	RS232-RX	RS232-GND					

2<sup>nd</sup> PRESS RUN BUTTON 2 sec

1<sup>st</sup> Turn On The POWER SWITCH

3<sup>rd</sup> PLUG OPERATOR PORT RS232

**STEP 4. Select the COM PORT from the PC Software.**

(Check the USB Port Number from the Microsoft Windows – Device Manager Page)  
Turn ON the Battery Module and press the CONNECT BUTTON

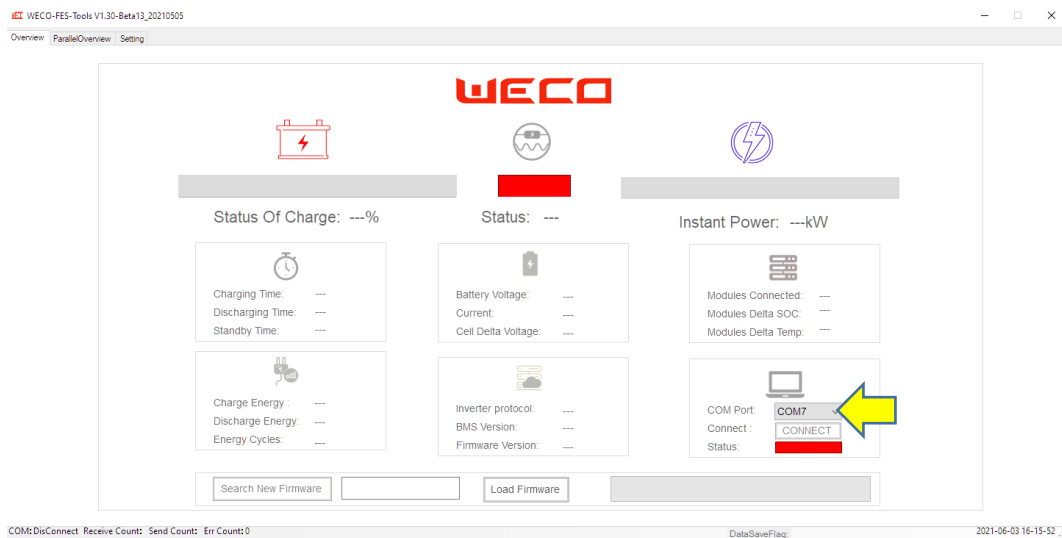

**STEP 5. When the communication is established between the PC and the Battery Module, the PC software will display a page like the one below:**



If more than one battery is connected in parallel, all the information will be displayed on this page. These pages will automatically update for up to 15 modules.

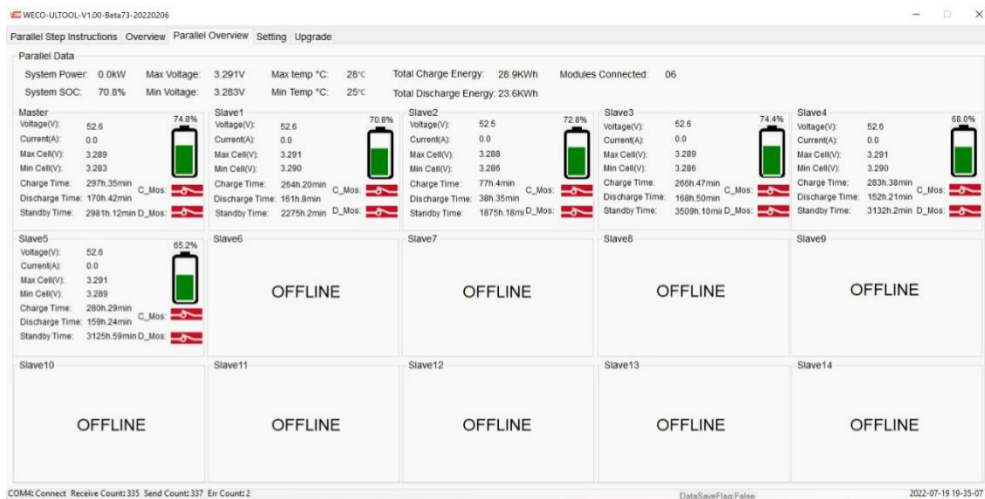

**STEP 6. LOW VOLTAGE PROTOCOL MODIFICATION**

In order to connect the battery with an inverter other than the default one, it is necessary to access the SETTING page and select the CAN protocol needed to communicate with the inverter.

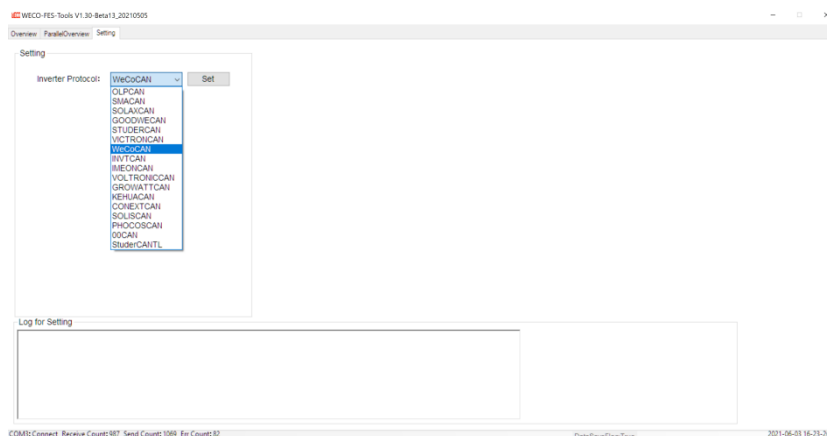

**STEP 7. FIRMWARE UPGRADE**

To update the firmware to a more recent version, it is necessary to download the latest version of the WeCo BMS software [www.wecobatteries.com](http://www.wecobatteries.com) and install it from the software as indicated.

**ATTENTION**

FOR XP BATTERIES SELECT ONLY XP-FIRMWARES (.bin) **DO NOT USE LV/HV FIRMWARE (.hex)**

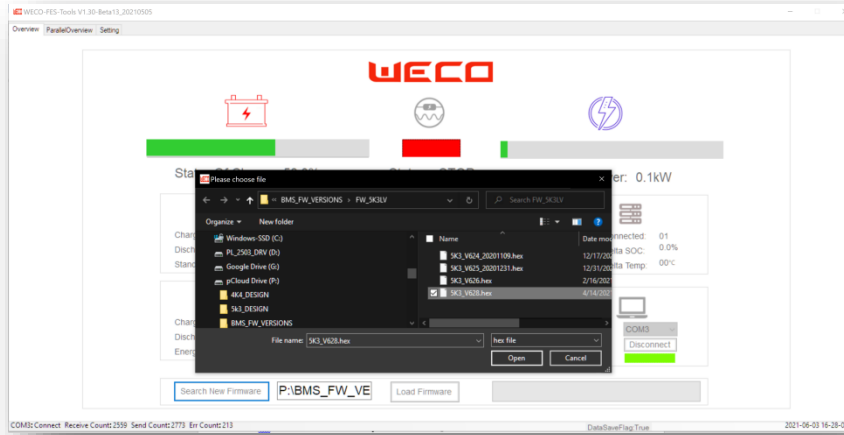

Make sure that the connection between the battery converter and the PC is stable for the duration of the update process. Do not disconnect the connection before the software has confirmed the upgrade.

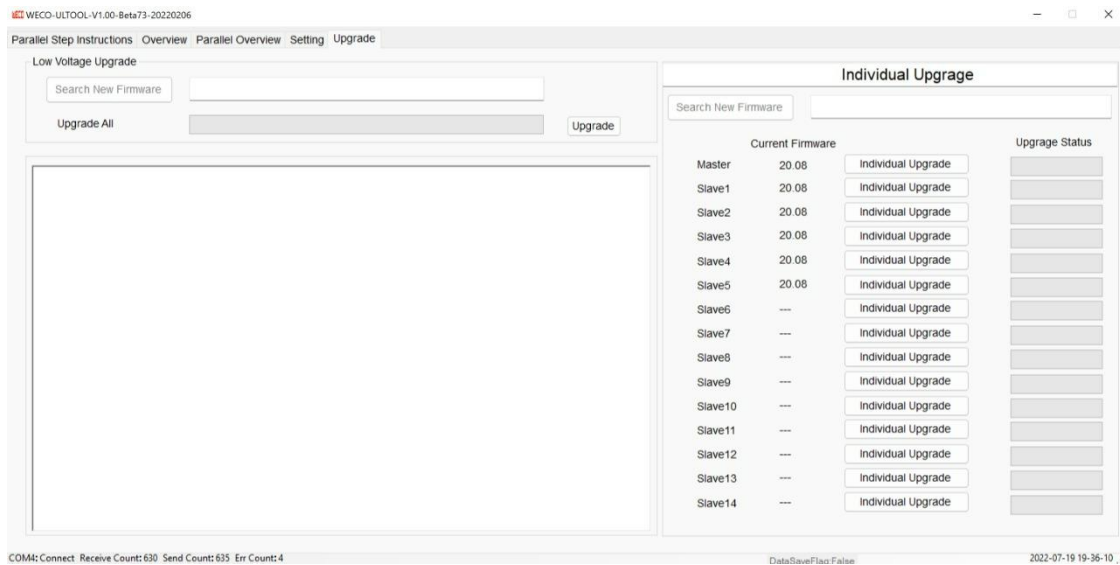

### 3.11 WECO BMS - HIGH VOLTAGE PC SOFTWARE for 5K3-XP

Use an Opto-Isolated RS232-USB Converter for the connection between PC and HV BOX.

**STEP 1.** Connect the RJ45 Port with the Operator Port located in the front of the HV BOX.  
**TURN ON THE MAIN BREAKER**

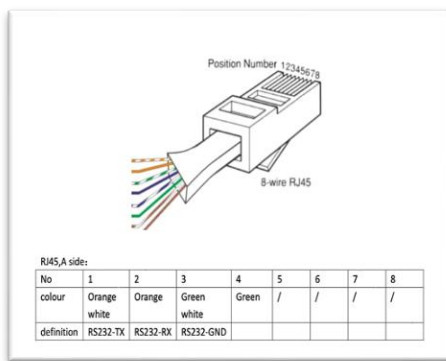
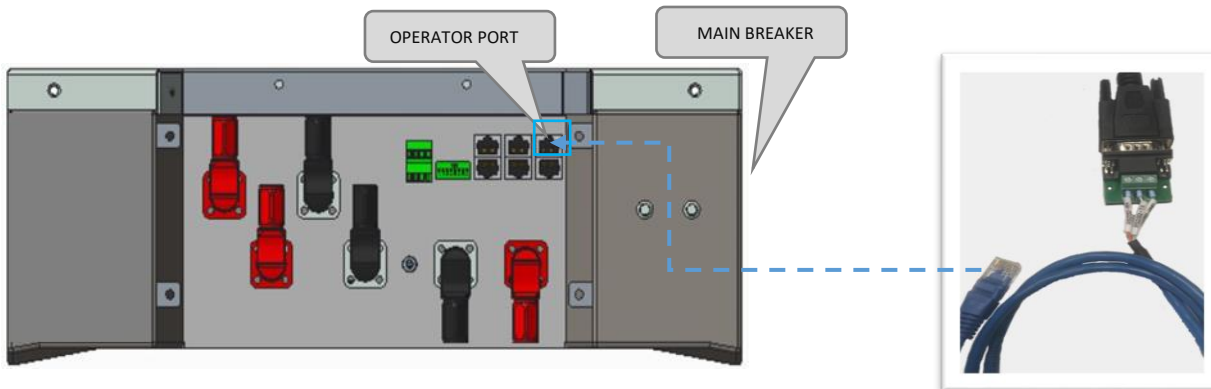

**STEP 2.** Select the COM PORT and press CONNECT.

After the communication is established correctly, the PC software will display the system general information as shown below:

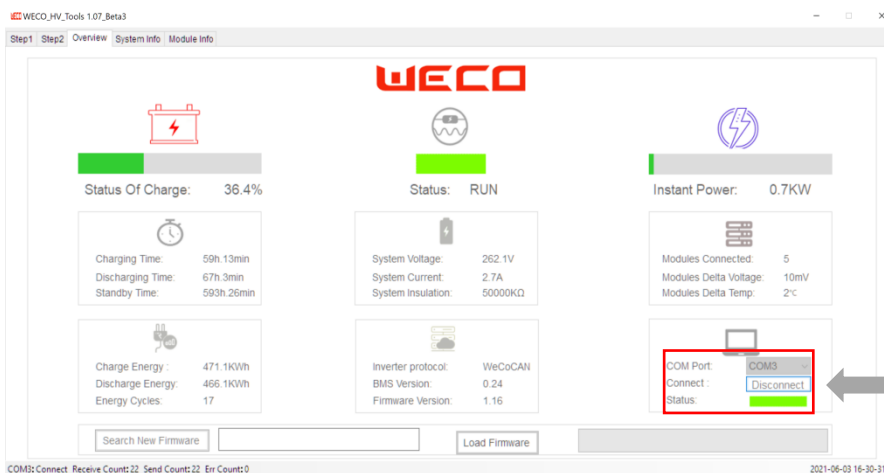

**STEP 3. SYSTEM INFORMATION**

From this page it is possible to view the modules that make up the system. It is also possible to monitor the voltage and current status of each individual module and any warnings or alarms.

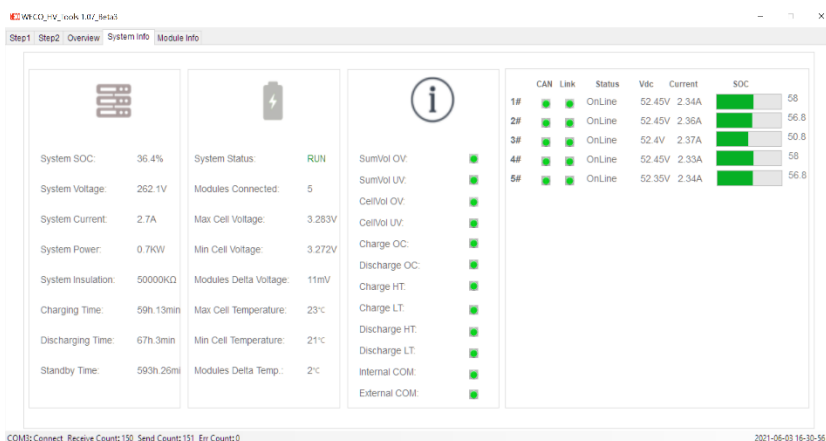

**STEP 4. MODULE INFORMATION**

From this page it is possible to view the individual cells of each module by selecting the desired module at the bottom of the screen

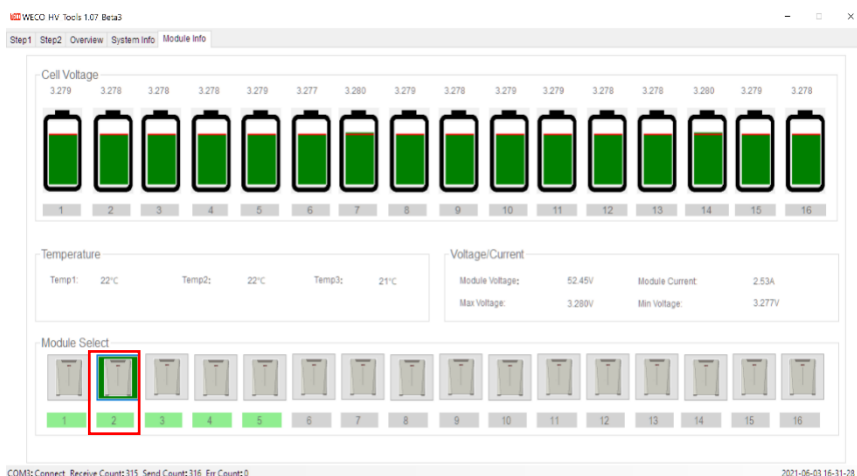

**STEP 5. HV BOX FIRMWARE UPGRADE**

By selecting the SEARCH NEW FIRMWARE, it is possible to search for the new HV BOX XP Firmware available (visit [www.wecobatteries.com](http://www.wecobatteries.com) to find the latest version).

After selecting the file, press LOAD FIRMWARE to launch the Firmware Upgrade.

**ATTENTION:** FOR XP BATTERIES SELECT ONLY XP-FIRMWARES ( .bin) **DO NOT USE LV/HV FIRMWARE (.hex)**

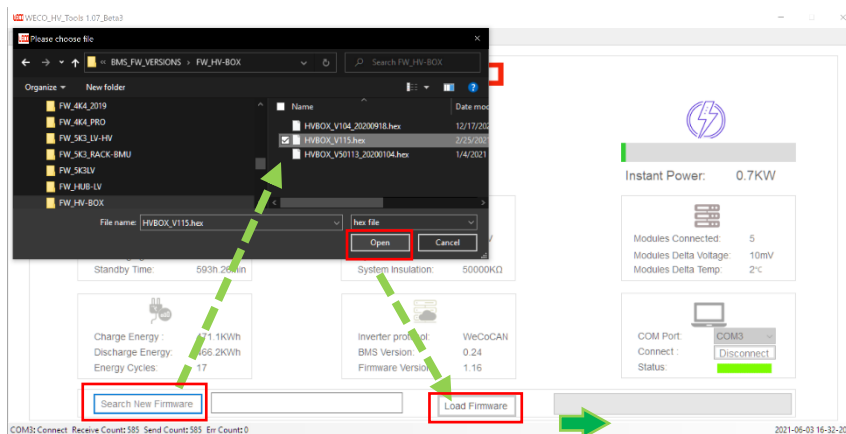

After confirming the File and clicking on the LOAD FIRMWARE button, the update procedure will begin and the HV BOX will be updated to the latest version.

The internal contactor may open and close several times after the update procedure is completed.

**MOBILE Bluetooth APP**

Install the WECO App by downloading it from the App Store / Google Play

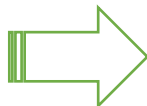

Search For:  
**WiFi**  
**WeCo WiFi**  
To get the Remote Monitoring APP

Search For:  
**Bluetooth**  
**WeCo Bluetooth**  
To get the Local APP

**Android WiFi**



**Android Bluetooth**



**IOS WiFi**



**IOS Android**



## MOBILE APP GENERAL OVERVIEW + FIRMWARE UPGRADE

### Operator Access

The screenshots illustrate the following steps:

- Login Screen:** Shows the WECO logo and a password field. A callout box states: "Password 1010 is required for Private User". A red "Login" button is at the bottom.
- Bluetooth Adapter Settings:** Shows the Bluetooth adapter is turned off. A callout box says: "Enable the Bluetooth function".
- Main Dashboard:** Displays battery status: 52.52V Total Voltage, 0.0A Current, 0.00KWH, and 8.6% SOC. A callout box points to the "Inverter Protocol" dropdown (currently set to OLPCAN) with the text: "To Change BMS Protocol press here".
- Running Alarms or Warns:** A callout box points to the "alarm:" section, which currently shows "Cell Voltage High Warning". The text says: "Running Alarms or Warns will appear here".
- Software Upgrade:** Shows the "Software Version: 1.01" and an "Update" button. A callout box says: "Software upgrade" with an arrow pointing to the "Update" button.



## IMPORTANT INFORMATIONS



**NOTE:** All data subject to change without notice. No part of this document may be copied or reproduced, electronically or mechanically, without written permission from the company.

Before installing your WeCo Battery Modules, please contact your WeCo representative for the latest manual and any additional support.



**ATTENTION CHARGING / DISCHARGING LIMITS:** The charge and discharge current of the inverter **MUST** be limited according to the maximum current allowed by each cluster configuration.

The charge and discharge voltage range of the inverter **MUST** be limited as per the Battery Module maximum value.



**ATTENTION WARRANTY INFORMATION:** In addition to the factory warranty, WeCo offers a performance guarantee for a period of 10 years from the date of manufacture of the battery. To benefit from the performance guarantee, the battery must be used in compliance with the STC (standard test conditions) requirements described in the limited warranty document.

Use outside the charge / discharge current and temperature and / or temperature and / or DOD ranges is not covered by the performance guarantee.

It is recommended to use the indoor battery at a controlled temperature to ensure the best storage conditions of the battery over time.



**ATTENTION, BATTERY ALARMS/WARNS** In the presence of any alarm / warns on both the battery and the inverter, the user must switch off and disconnect the power connection between the batteries and the inverter.

The battery must be inspected immediately with an authorized WeCo technician or send the battery to WeCo for an accurate check.



**ATTENTION, RECYCLE AND DISPOSAL,** Follow the Local and International rules for the recycle and disposal of any product or packaging supplied by WeCo.

Lithium Battery must be recycled by specialized companies. Do not dispose into domestic waste container, incinerate, disassemble or leave in uncontrolled and restricted areas when at end of life or damaged.

Cables and electrical devices and accessories must be disposed into special containers and delivered to specialize recycle centers.

Packaging in Carton and or Plastic to be disposed in specific recycle container as per you Country rules.



WeCo srl  
Viale Kennedy 113-121 Scarperia  
Firenze Italia  
[www.wecobatteries.com](http://www.wecobatteries.com)

All data subject to change without notice. Actual product color may vary. No part of this document can be copied or reproduced, electronically or mechanically, without written permission from the company.